

# ILLUSTRATED PRODUCT GUIDE

January 2005



## JESCO LIGHTING

### **NEW YORK OFFICE**

66-25 Traffic Avenue  
Glendale, NY 11385  
Tel: 718.366.3211  
Toll Free: 800.527.7796  
Fax: 718.366.3646

### **LOS ANGELES OFFICE**

1100 Hatcher Avenue, Suite A  
City of Industry, CA 91748  
Tel: 626.854.8168  
Fax: 626.854.8172

[www.jescolighting.com](http://www.jescolighting.com)

**TRACK LIGHTING**

	1 – 3
- LOW VOLTAGE TRACK FIXTURE	3
- LOW VOLTAGE FIXTURE EXTENDERS	4 – 5
- LINE VOLTAGE TRACK FIXTURES	6
- METAL HALIDE TRACK FIXTURES	7
- COMPACT FLUORESCENT TRACK FIXTURES	8 – 9
- SINGLE CIRCUIT TRACK & ACCESSORIES	

**RECESSED LIGHTING**

- MINIATURE LOW VOLTAGE GLASS DOWNLIGHTS	10
- 4" LOW VOLTAGE TRIMS	11
- 4" LOW VOLTAGE HOUSINGS	12
- 4" LINE VOLTAGE TRIMS	13
- 4" LINE VOLTAGE HOUSINGS	14
- 4" METAL HALIDE TRIMS	15
- 4" METAL HALIDE HOUSINGS	16
- 6" LINE VOLTAGE TRIMS	17 – 18
- 6" LINE VOLTAGE HOUSINGS	19
- 6" COMMERCIAL METAL HALIDE TRIMS	20
- 6" COMMERCIAL METAL HALIDE HOUSINGS	21 – 22
- 8" COMMERCIAL HORIZONTAL COMPACT FLUORESCENT TRIMS	23
- 8" COMMERCIAL HORIZONTAL COMPACT FLUORESCENT HOUSINGS	23 – 24
- 8" ARCHITECTURAL INCANDESCENT TRIMS	25
- 8" ARCHITECTURAL INCANDESCENT HOUSINGS	25
- 8" ARCHITECTURAL METAL HALIDE TRIMS	26
- 8" ARCHITECTURAL METAL HALIDE HOUSINGS	26
- 8" ARCHITECTURAL VERTICAL COMPACT FLUORESCENT TRIMS	27
- 8" ARCHITECTURAL VERTICAL COMPACT FLUORESCENT HOUSINGS	27
- 8" ARCHITECTURAL HORIZONTAL COMPACT FLUORESCENT TRIMS	28
- 8" ARCHITECTURAL HORIZONTAL COMPACT FLUORESCENT HOUSINGS	28 – 29
- QUICK START RECESSED HOUSINGS/TRIMS	30
- LOW VOLTAGE MODULES	31
- LINE VOLTAGE MODULES	32

**DISPLAY LIGHTING**

- SLEEK PLUS T4 FLUORESCENT LIGHTING SYSTEM	33
- SLEEK PLUS T5 FLUORESCENT LIGHTING SYSTEM	34
- SLEEK PLUS T5 CORNER LIGHT FLUORESCENT LIGHTING SYSTEM	35
- SLEEK PLUS T4 & T5 FLUORESCENT LIGHTING SYSTEM COMPONENTS	36
- SLEEK MODULES T5 FLUORESCENT LIGHTING SYSTEM	37
- SLEEK MODULES T5 FLUORESCENT LIGHTING SYSTEM - COMPONENTS	37
- REPLACEMENT T4 LAMPS	38
- REPLACEMENT T5 LAMPS	39
- COLD CATHODE FLUORESCENT (CCF)	40
- STEP 1. SPECIFY THE NUMBER OF LAMPS, LENGTH AND COLOR TEMPERATURE	40 – 41
- STEP 2. SPECIFY THE LAMP/REFLECTOR CONFIGURATION, AND REFLECTOR TYPE	42
- STEP 3. MATCH UP THE TOTAL WATTAGE TO THE APPROPRIATE POWER SUPPLY	43
- XENON MINUET	44
- CUP LIGHTS	44
- ARCLIGHTS	45
- HALOGEN PUCK LIGHTS	46
- XENON PUCK LIGHTS	46
- MINI RECESSED	47

**TRANSFORMERS**

	48 – 49
--	---------

**DECORATIVES**

- FLOATING GLASS SERIES – CABLE HUNG	50
- FLOATING GLASS SERIES – SURFACE MOUNTED	51
- CEILING FIXTURES - 1-LIGHT & 3-LIGHT LOW VOLTAGE FIXTURES	52 – 54
- CEILING FIXTURES - 1-LIGHT & 3-LIGHT LINE VOLTAGE FIXTURES	55
- CEILING FIXTURES - 1-LIGHT LOW & LINE VOLTAGE FIXTURE EXTENDERS	55

**OUTDOOR GEMSTEEL STAINLESS STEEL**

- GEMSTEEL WALL MEDIA	56
- GEMSTEEL BEAMERS	56
- GEMSTEEL TRI-BAFFLE MONITORS	57
- GEMSTEEL FIVE-BAFFLE MONITORS	57
- MOONGLO GLOBE SERIES	58
- SPECIALTIES	58

**LAMPS**

- HALOGEN LAMPS – JC-BI-PIN	59
- HALOGEN LAMPS – MR16 DICHROIC REFLECTOR	59
- HALOGEN LAMPS – MR11 DICHROIC REFLECTOR	59
- HALOGEN LAMPS – DICHROIC REFLECTOR FOR LINE VOLTAGE	59
- HALOGEN PAR LAMPS – PAR20	60
- HALOGEN PAR LAMPS – PAR30L (LONG NECK)	60
- HALOGEN PAR LAMPS – PAR38	60
- XENON LAMPS – BI-PIN	60
- COMPACT FLUORESCENT LAMPS – PL-C CLUSTER 4-PIN FLUORESCENT LAMPS	61
- COMPACT FLUORESCENT LAMPS – PL-L LONG FLUORESCENT LAMPS	61
- COMPACT FLUORESCENT LAMPS – PL-T TRIPLE 4-PIN FLUORESCENT LAMPS	61
- FLUORESCENT LAMPS – T4	62
- FLUORESCENT LAMPS – T5	63
- METAL HALIDE PAR LAMPS – PAR20	64
- METAL HALIDE PAR LAMPS – PAR30L (LONG NECK)	64
- METAL HALIDE PAR LAMPS – PAR38	64
- ES16 (GX10 BASE) METAL HALIDE LAMPS	64

**INDEX**

# TRACK LIGHTING - LOW VOLTAGE TRACK FIXTURES

## Systems:

- CM: Single circuit 3-wire system. Fixtures are compatible with any "H" systems.  
 LV: Single circuit 2-wire system. Fixtures are compatible with any "L" systems.  
 JT: Single circuit wide 2-wire system. Fixtures are compatible with any "J" systems.

## CM SYSTEM



## LV SYSTEM



## JT SYSTEM



	MODEL DESCRIPTION	FINISH	CM SYSTEM		LV SYSTEM		JT SYSTEM		STD PKG PCS/WGT
			50W	75W	50W	75W	50W	75W	
	<b>100</b> Accordian – Die Cast Lamp: 12V MR16 2-3/4"Ø x 3-1/4"L x 6-1/4"Ext 90°vertical, 330° horizontal rotation	BK, WH	<b>CM100</b>	<b>CM100H</b>	<b>LV100</b>	<b>LV100H</b>	<b>JT100</b>	<b>JT100H</b>	24/22lbs
	<b>102</b> Soft Square – Die Cast Lamp: 12V MR16 2-3/8"Ø x 3"L x 5-1/8"Ext 150°vertical, 330° horizontal rotation	BK, WH ST	<b>CM102</b>	<b>CM102H</b>	<b>LV102</b>	<b>LV102H</b>	<b>JT102</b>	<b>JT102H</b>	24/22lbs
	<b>104</b> Net – Die Cast Lamp: 12V MR16 2-7/8"Ø x 3-1/8"L x 6-1/2"Ext 90°vertical, 330° horizontal rotation	BK, WH	<b>CM104</b>	<b>CM104H</b>	<b>LV104</b>	<b>LV104H</b>	<b>JT104</b>	<b>JT104H</b>	24/18lbs
	<b>106</b> Saturn – Die Cast Lamp: 12V MR16 4"Ø x 4-1/2"L x 5-3/8"Ext 90°vertical, 330° horizontal rotation	BK, WH ST With Clear Acrylic Disk	<b>CM106</b>	<b>CM106H</b>	<b>LV106</b>	<b>LV106H</b>	<b>JT106</b>	<b>JT106H</b>	24/17lbs
	<b>107</b> Tropic Glass – Die Cast Lamp: 12V MR16 3-1/4"Ø x 3-1/8"L x 6"Ext 90°vertical, 330° horizontal rotation	BK, WH Glass Options: BU, FR	<b>CM107</b>	<b>CM107H</b>	<b>LV107</b>	<b>LV107H</b>	<b>JT107</b>	<b>JT107H</b>	24/20lbs
	<b>108</b> Classic – Die Cast Lamp: 12V MR16 4"Ø x 3-1/2"L x 4-3/8"Ext 90°vertical, 330° horizontal rotation	BK, WH	<b>CM108</b>	<b>CM108H</b>	<b>LV108</b>	<b>LV108H</b>	<b>JT108</b>	<b>JT108H</b>	24/19lbs
	<b>109</b> Round – Die Cast Lamp: 12V MR16 2-1/4"Ø x 3"L x 5-1/4"Ext 150°vertical, 330° horizontal rotation	BK, WH ST	<b>CM109</b>	<b>CM109H</b>	<b>LV109</b>	<b>LV109H</b>	<b>JT109</b>	<b>JT109H</b>	24/22lbs
	<b>110</b> Step Baffle Roundback Lamp: 12V MR16 2-5/8"Ø x 3-1/4"L x 6-1/4"Ext 180°vertical, 330° horizontal rotation	BK, WH	<b>CM110</b>	<b>CM110H</b>	<b>LV110</b>	<b>LV110H</b>	<b>JT110</b>	<b>JT110H</b>	24/20lbs
	<b>113</b> Pendulum Lamp: 12V MR16 5-1/8"Ø x 2-1/2"H Cable: 48" max	BK, WH ST Glass Options: AM, BU, FR, GN	<b>CM113</b>	<b>CM113H</b>	<b>LV113</b>	<b>LV113H</b>	<b>JT113</b>	<b>JT113H</b>	24/32lbs
	<b>114</b> Conical Pendulum Lamp: 12V MR16 5-1/8"Ø x 2-1/2"H Cable: 48" max	BK, WH ST Glass Options: AM, BU, FR	<b>CM114</b>	<b>CM114H</b>	<b>LV114</b>	<b>LV114H</b>	<b>JT114</b>	<b>JT114H</b>	24/32lbs
	<b>115</b> Frosted Glass Disk - Die Cast Lamp: 12V MR16 3-1/2"Ø x 4-1/8"L x 6-1/2"Ext 90°vertical, 330° horizontal rotation	BK, WH	<b>CM115</b>	<b>CM115H</b>	<b>LV115</b>	<b>LV115H</b>	<b>JT115</b>	<b>JT115H</b>	24/22lbs
	<b>116</b> Star Ship – Die Cast Lamp: 12V MR16 2-3/8"Ø x 3-1/4"L x 5-1/2"Ext 90°vertical, 330° horizontal rotation	BK, WH Glass Options: BU, FR	<b>CM116</b>	<b>CM116H</b>	<b>LV116</b>	<b>LV116H</b>	<b>JT116</b>	<b>JT116H</b>	24/18lbs

TRACK LIGHTING – LOW VOLTAGE TRACK FIXTURES ... cont'd

**Systems:**

CM: Single circuit 3-wire system. Fixtures are compatible with any "H" systems.  
 LV: Single circuit 2-wire system. Fixtures are compatible with any "L" systems.  
 JT: Single circuit wide 2-wire system. Fixtures are compatible with any "J" systems.

**CM SYSTEM**





**LV SYSTEM**



**JT SYSTEM**



	MODEL DESCRIPTION	FINISH	CM SYSTEM		LV SYSTEM		JT SYSTEM		STD PKG PCS/WGT
			50W	75W	50W	75W	50W	75W	
	<b>120</b> Olympic – Die Cast Lamp: 12V MR16 2-1/4"Ø x 3-1/2"L x 6-1/4"Ext 90°vertical, 330° horizontal rotation	PBST, ST	<b>CM120</b>	<b>CM120H</b>	<b>LV120</b>	<b>LV120H</b>	<b>JT120</b>	<b>JT120H</b>	24/22lbs
	<b>122</b> Glass Tech – Die Cast Lamp: 12V MR16 3-1/4"Ø x 4"L x 6-3/4"Ext 90°vertical, 330° horizontal rotation	CHBK, CHWH ST  Glass Options: AM, BU, FR, GN, PK	<b>CM122</b>	<b>CM122H</b>	<b>LV122</b>	<b>LV122H</b>	<b>JT122</b>	<b>JT122H</b>	24/19lbs
	<b>123</b> Rocket – Die Cast Lamp: 12V MR16 2-1/4"Ø x 2-3/4"L x 5-3/4"Ext 90°vertical, 330° horizontal rotation	ST	<b>CM123</b>	<b>CM123H</b>	<b>LV123</b>	<b>LV123H</b>	<b>JT123</b>	<b>JT123H</b>	24/20lbs
	<b>127</b> Spurs – Die Cast Lamp: 12V MR16 2-1/4"Ø x 4-3/8"L x 6"Ext 90°vertical, 330° horizontal rotation	ST	<b>CM127</b>	<b>CM127H</b>	<b>LV127</b>	<b>LV127H</b>	<b>JT127</b>	<b>JT127H</b>	24/19lbs
	<b>130</b> Step Baffle – Die Cast Lamp: 12V MR16 3-1/4"Ø x 2-3/4"L x 5-3/4"Ext 90°vertical, 330° horizontal rotation	BK, WH	<b>CM130</b>	<b>CM130H</b>	<b>LV130</b>	<b>LV130H</b>	<b>JT130</b>	<b>JT130H</b>	24/20lbs
	<b>132</b> Gimbal Lamp: 12V MR16 2"Ø x 4"L x 4-5/8"Ext 90°vertical, 330° horizontal rotation	BK, WH ST	<b>CM132</b>	<b>CM132H</b>	<b>LV132</b>	<b>LV132H</b>	<b>JT132</b>	<b>JT132H</b>	24/14lbs
	<b>138</b> Renaissance – Die Cast Lamp: 12V MR16 2-3/4"Ø x 4-1/8"L x 6-3/4"Ext 90°vertical, 330° horizontal rotation	ST  Glass Options: AM, BU, FR	<b>CM138</b>	<b>CM138H</b>	<b>LV138</b>	<b>LV138H</b>	<b>JT138</b>	<b>JT138H</b>	24/25lbs
	<b>140</b> Bullet – Die Cast Lamp: 12V MR16 2-3/8"Ø x 3-1/2"L x 6-1/2"Ext 90°vertical, 330° horizontal rotation	BK, WH ST	<b>CM140</b>	<b>CM140H</b>	<b>LV140</b>	<b>LV140H</b>	<b>JT140</b>	<b>JT140H</b>	24/24lbs
	<b>143</b> Gimbal Plus – Die Cast Lamp: 12V MR16 2-3/8"Ø x 4-1/8"L x 6-1/4"Ext 90°vertical, 330° horizontal rotation	BK, WH ST	<b>CM143</b>	<b>CM143H</b>	<b>LV143</b>	<b>LV143H</b>	<b>JT143</b>	<b>JT143H</b>	24/23lbs
	<b>147</b> Tropic – Die Cast Lamp: 12V MR16 2-1/4"Ø x 3-1/8"L x 6-3/4"Ext 90°vertical, 330° horizontal rotation	ST  Glass Options: AM, BU, FR	<b>CM147</b>	<b>CM147H</b>	<b>LV147</b>	<b>LV147H</b>	<b>JT147</b>	<b>JT147H</b>	24/19lbs
	<b>151</b> Stylite Round – Die Cast Lamp: 12V AR111 (included) 5"Ø x 1-3/8"L x 7-1/2"Ext 90°vertical, 330° horizontal rotation	BK, WH ST	<b>CM151</b>	<b>CM151H</b>	<b>LV151</b>	<b>LV151H</b>	<b>JT151</b>	<b>JT151H</b>	24/26lbs
	<b>152</b> Stylite Square – Die Cast Lamp: 12V AR111 (included) 5"Ø x 1-3/8"L x 8-1/4"Ext 90°vertical, 330° horizontal rotation	BK, WH ST	<b>CM152</b>	<b>CM152H</b>	<b>LV152</b>	<b>LV152H</b>	<b>JT152</b>	<b>JT152H</b>	24/31lbs

## TRACK LIGHTING – LOW VOLTAGE TRACK FIXTURES ... cont'd

### Systems:

- CM: Single circuit 3-wire system. Fixtures are compatible with any "H" systems.  
 LV: Single circuit 2-wire system. Fixtures are compatible with any "L" systems.  
 JT: Single circuit wide 2-wire system. Fixtures are compatible with any "J" systems.

### CM SYSTEM





### LV SYSTEM



### JT SYSTEM



	MODEL DESCRIPTION	FINISH	CM SYSTEM		LV SYSTEM		JT SYSTEM		STD PKG PCS/WGT
			50W	75W	50W	75W	50W	75W	
	<b>158</b> Framing Projector – Die Cast 4 adjustable framing shutters define geometrical forms. Lamp: 12V MR16 1-1/8" Ø x 7"L x 9-5/8"Ext 90° vertical, 330° horizontal rotation	WH	CM158	CM158H	LV158	LV158H	JT158	JT158H	24/37lbs
	<b>240</b> Plano Lamp: 12V MR16 2-1/8"Ø x 3-1/4"L x 6-3/4"Ext 90° vertical, 330° horizontal rotation	ST	CM240	CM240H	LV240	LV240H	JT240	JT240H	24/18lbs
	<b>806</b> Saucer Lamp: 12V MR16 3-3/4"Ø x 2-7/8"L x 6-1/8"Ext 90° vertical, 330° horizontal rotation	CHBK, CHWH CHST  Glass Options: AM, BU, FR,GN,PK	CM806	CM806H	LV806	LV806H	JT806	JT806H	24/18lbs

### Finish Key – Fixtures:

- BK: Black fixture, Black transformer adapter  
 CHBK: Chrome fixture, Black transformer adapter  
 CHST: Chrome fixture, Satin Chrome transformer adapter  
 CHWH: Chrome fixture, White transformer adapter  
 PBST: Polished brass fixture, Satin Chrome transformer adapter  
 ST: Satin Chrome fixture, Satin Chrome transformer adapter  
 WH: White fixture, White transformer adapter

### Finish Key – Glass Options:

- AM: Amber  
 BU: Blue  
 CL: Clear  
 FR: Frosted  
 GN: Green  
 PK: Pink

### Ordering Instructions:

SYSTEM	MODEL	75w Add "H"	GLASS OPTION	-	FINISH
--------	-------	-------------	--------------	---	--------



### Example:

1. Model 109 in LV system, 50w, Black fixture/black transformer box: LV109-BK  
 2. Model 806 in CM system, 75w, blue glass, Chrome fixture/black transformer box: CM806HBU-CHBK

### Note:

All fixtures are not lamped, unless specified. For fixtures with lamps, please consult factory.

## TRACK LIGHTING – LOW VOLTAGE TRACK FIXTURES – FIXTURE EXTENDERS

ROD FIXTURE EXTENDER		GOOSENECK FIXTURE EXTENDER	
MODEL	DESCRIPTION	MODEL	DESCRIPTION
	FINISH		FINISH
	<b>SK212</b> 12" Rod Fixture Extender		<b>GN212</b> 12" Gooseneck Fixture Extender
	BK, WH ST		ST
	<b>SK218</b> 18" Rod Fixture Extender		<b>GN218</b> 18" Gooseneck Fixture Extender
	BK, WH ST		ST
	<b>SK224</b> 24" Rod Fixture Extender		<b>GN224</b> 24" Gooseneck Fixture Extender
	BK, WH ST		ST
	<b>SK236</b> 36" Rod Fixture Extender		
	BK, WH ST		
	<b>SK248</b> 48" Rod Fixture Extender		
	BK, WH ST		

### Pricing:

Fixture Extenders are for Low Voltage Track Fixtures only. Available as a complete unit from the factory. When ordering, please specify fixture style, extension type and length.

### Finish Key:

- BK: Black  
 ST: Satin Chrome  
 WH: White

# TRACK LIGHTING – LINE VOLTAGE TRACK FIXTURES

## Systems:

CM: Single circuit 3-wire system. Fixtures are compatible with any “H” systems.  
 LV: Single circuit 2-wire system. Fixtures are compatible with any “L” systems.  
 JT: Single circuit wide 2-wire system. Fixtures are compatible with any “J” systems.

## CM SYSTEM



## LV SYSTEM



## JT SYSTEM



	MODEL DESCRIPTION	LAMP TYPE MAX WATT	FINISH	CM SYSTEM	LV SYSTEM	JT SYSTEM	STD PKG PCS/WGT
	<b>37</b> Step Baffle Roundback – Small 3-1/2"Ø x 6"L x 9"Ext 90°vertical, 330° horizontal rotation	Par20, R20 120v 60w Max	BK, WH	<b>CM37</b>	<b>LV37</b>	<b>JT37</b>	24/31lbs
	<b>38</b> Step Baffle Roundback–Medium 4-3/8"Ø x 6-3/4"L x 10"Ext 90°vertical, 330° horizontal rotation	Par30, R30 120v 75w Max	BK, WH	<b>CM38</b>	<b>LV38</b>	<b>JT38</b>	24/29lbs
	<b>39</b> Step Baffle Roundback – Large 5-7/8"Ø x 7"L x 10"Ext 90°vertical, 330° horizontal rotation	Par38, R40 120v 150w Max	WH	<b>CM39</b>	<b>LV39</b>	<b>JT39</b>	24/48lbs
	<b>99</b> Short Universal 2"Ø x 3-1/2"L x 6-1/4"Ext 90°vertical, 330° horizontal rotation	Par20, 30, 38 R20, 30, 40 120v 150w Max	BK, WH	<b>CM99</b>	<b>LV99</b>	<b>JT99</b>	24/14lbs
	<b>G127</b> Spurs – Die Cast 2-1/2"Ø x 4-3/8"L x 6"Ext 90°vertical, 330° horizontal rotation	MR16 GU10 120v 50w Max (included)	ST	<b>CMG127</b>	<b>LVG127</b>	<b>JTG127</b>	24/19lbs
	<b>G138</b> Renaissance – Die Cast 2-3/4"Ø x 4-1/8"L x 6-3/4"Ext 90°vertical, 330° horizontal rotation	MR16 GU10 120v 50w Max (included)	ST  Glass Options: AM, BU, FR	<b>CMG138</b>	<b>LVG138</b>	<b>JTG138</b>	24/25lbs
	<b>220</b> Gimbal – Small 2-1/2"Ø x 4-1/2"L x 6-3/8"Ext 90°vertical, 330° horizontal rotation	Par20, R20 120v 60w Max	BK, WH ST	<b>CM220</b>	<b>LV220</b>	<b>JT220</b>	24/19lbs
	<b>230</b> Gimbal – Medium 4"Ø x 5-7/8"L x 7-5/8"Ext 90°vertical, 330° horizontal rotation	Par30, R30 120v 75w Max	BK, WH ST	<b>CM230</b>	<b>LV230</b>	<b>JT230</b>	24/21lbs
	<b>238</b> Gimbal – Large 5-1/8"Ø x 6-1/2"L x 9-5/8"Ext 90°vertical, 330° horizontal rotation	Par38, R40 120v 150w Max	BK, WH ST	<b>CM238</b>	<b>LV238</b>	<b>JT238</b>	24/25lbs
	<b>G240</b> Plano 2-1/8"Ø x 3-1/2"L x 6-3/4"Ext 90°vertical, 330° horizontal rotation	MR16 GU10 120v 50w Max (included)	ST	<b>CMG240</b>	<b>LVG240</b>	<b>JTG240</b>	24/21lbs
	<b>330</b> Flexible Gimbal – Die Cast 2-3/4"Ø x 4-1/8"L x 6-3/4"Ext 90°vertical, 330° horizontal rotation	Par30, R30 120v 75w Max	BK, WH ST	<b>CM330</b>	<b>LV330</b>	<b>JT330</b>	24/26lbs
	<b>338</b> Flexible Gimbal – Die Cast 5-7/8"Ø x 6-3/8"L x 10-3/8"Ext 90°vertical, 330° horizontal rotation	Par38, R40 120v 150w Max	BK, WH ST	<b>CM338</b>	<b>LV338</b>	<b>JT338</b>	24/28lbs

# TRACK LIGHTING – LINE VOLTAGE TRACK FIXTURES ... cont'd

## Systems:

CM: Single circuit 3-wire system. Fixtures are compatible with any "H" systems.  
 LV: Single circuit 2-wire system. Fixtures are compatible with any "L" systems.  
 JT: Single circuit wide 2-wire system. Fixtures are compatible with any "J" systems.

## CM SYSTEM











## LV SYSTEM



## JT SYSTEM



	MODEL DESCRIPTION	LAMP TYPE MAX WATT	FINISH	CM SYSTEM	LV SYSTEM	JT SYSTEM	STD PKG PCS/WGT
	<b>420</b> Deco – Small – Die Cast 2-7/8"Ø x 5"L x 6-7/8"Ext 90°vertical, 330° horizontal rotation	Par20, R20 120v 60w Max	BK, WH ST	<b>CM420</b>	<b>LV420</b>	<b>JT420</b>	24/20lbs
	<b>430</b> Deco – Medium – Die Cast 4-1/8"Ø x 5-1/4"L x 7-5/8"Ext 90°vertical, 330° horizontal rotation	Par30, R30 120v 75w Max	BK, WH ST	<b>CM430</b>	<b>LV430</b>	<b>JT430</b>	24/23lbs
	<b>607</b> Step Baffle – Small 3-7/8"Ø x 5-1/4"L x 7-1/4"Ext 90°vertical, 330° horizontal rotation	Par20, R20 120v 60w Max	BK, WH	<b>CM607</b>	<b>LV607</b>	<b>JT607</b>	24/24lbs
	<b>617</b> Step Baffle – Medium 4-1/2"Ø x 6-1/2"L x 9"Ext 90°vertical, 330° horizontal rotation	Par30, R30 120v 75w Max	BK, WH	<b>CM617</b>	<b>LV617</b>	<b>JT617</b>	24/25lbs
	<b>620</b> Step Baffle Flatback – Small 3-1/2"Ø x 6"L x 8-3/8"Ext 90°vertical, 330° horizontal rotation	Par20, R20 120v 60w Max	BK, WH	<b>CM620</b>	<b>LV620</b>	<b>JT620</b>	24/28lbs
	<b>630</b> Step Baffle Flatback – Medium 4"Ø x 6-3/8"L x 6-5/8"Ext 90°vertical, 330° horizontal rotation	Par30, R30 120v 75w Max	BK, WH	<b>CM630</b>	<b>LV630</b>	<b>JT630</b>	24/32lbs
	<b>650</b> Universal 2"Ø x 4-3/8"L x 7-1/2"Ext 90°vertical, 330° horizontal rotation	Par20, 30, 38 R20, 30, 40 120v 150w Max	BK, WH ST	<b>CM650</b>	<b>LV650</b>	<b>JT650</b>	24/18lbs
	<b>730</b> Bell – Medium 5-3/4"Ø x 6-3/4"L x 9"Ext 90°vertical, 330° horizontal rotation	Par30, R30 120v 75w Max	WH PBBK STBK	<b>CM730</b>	<b>LV730</b>	<b>JT730</b>	24/44lbs

## Finish Key:

BK: Black fixture, Black track adapter  
 CHBK: Chrome fixture, Black track adapter  
 CHWH: Chrome fixture, White track adapter  
 ST: Satin Chrome fixture, Satin Chrome track adapter  
 STBK: Satin Chrome fixture, Black track adapter  
 PBBK: Polished Brass fixture, Black track adapter  
 WH: White fixture, White track adapter

## Ordering Instructions:

SYSTEM	MODEL	GLASS OPTION	-	FINISH
--------	-------	--------------	---	--------

## Example:

1. Model 37in LV system Black fixture, black track adapter LV109-BK
2. Model G138 in CM system, blue glass, satin chrome fixture, black track adapter CMG138BU-ST
3. Model G127 in JT system, satin chrome fixture, black track adapter JTG127-ST

## Note:

All fixtures are not lamped, unless specified. For fixtures with lamps, please consult factory.

## TRACK LIGHTING – METAL HALIDE TRACK FIXTURES

Whitelite and Whitelite Satellite Metal Halide Track fixtures are designed for Par30 and Par38 metal halide lamps using ceramic arc tube technology. Because Par Metal Halide lamps provide brilliant white light and a very high CRI (Color Rendering Index) accompanied by a choice of beam angles, these fixtures are excellent choices for stores, showrooms, museums, and a broad range of display applications.

### Features:

- High Power Factor > 98%
- High efficiency electronic ballast
- Energy saving: 20% vs Magnetic ballast
- Voltage: 120v AC 50/60Hz; 277v available upon request
- Total harmonic distortion < 10%
- Reduction in visual flicker
- Increased lamp life
- Thermal protection – Automatic reset
- Ballast Min Operating temperature - 20°F
- Ballast Max Case temperature - 158°F

### Systems:

CM: Single circuit 3-wire system. Fixtures are compatible with any “H” systems.  
 LV: Single circuit 2-wire system. Fixtures are compatible with any “L” systems.  
 JT: Single circuit wide 2-wire system. Fixtures are compatible with any “J” systems.

### CM SYSTEM













### LV SYSTEM



### JT SYSTEM



	MODEL DESCRIPTION	LAMP TYPE MAX WATT	FINISH	CM SYSTEM	LV SYSTEM	JT SYSTEM	STD PKG PCS/WGT
	<b>MTA 3530</b> Whitelite 4-3/4"Ø x 6"L x 7-1/2"Ext 90°vertical, 358° horizontal rotation	Metal Halide Par30 120v 35w Max Ballast closure: 5" x 6-5/8"	BK, WH	<b>CMMTA3530</b>	<b>LVMTA3530</b>	<b>JTMTA3530</b>	6/23lbs
	<b>MTA 7030</b> Whitelite 4-3/4"Ø x 6"L x 7-1/2"Ext 90°vertical, 358° horizontal rotation	Metal Halide Par30 120v 70w Max Ballast closure: 5" x 6-5/8"	BK, WH	<b>CMMTA7030</b>	<b>LVMTA7030</b>	<b>JTMTA7030</b>	6/23lbs
	<b>MTA 7038</b> Whitelite 6"Ø x 6-1/2"L x 8-1/2"Ext 90°vertical, 358° horizontal rotation	Metal Halide Par38 120v 70w Max Ballast closure: 5" x 6-5/8"	BK, WH	<b>CMMTA7038</b>	<b>LVMTA7038</b>	<b>JTMTA7038</b>	6/23lbs
	<b>MTA 10038</b> Whitelite 6"Ø x 6-1/2"L x 8-1/2"Ext 90°vertical, 358° horizontal rotation	Metal Halide Par38 120v 100w Max Ballast closure: 5" x 6-5/8"	BK, WH	<b>CMMTA10038</b>	<b>LVMTA10038</b>	<b>JTMTA10038</b>	6/23lbs
	<b>MTB 3530</b> Whitelite Satellite Open Frame Adjustable 4-3/4"Ø x 6-1/8"L x 9-3/4"Ext 90°vertical, 358° horizontal rotation	Metal Halide Par30 120v 35w Max Ballast closure: 5" x 6-5/8"	BK, WH	<b>CMMTB3530</b>	<b>LVMTB3530</b>	<b>JTMTB3530</b>	6/29lbs
	<b>MTB 7030</b> Whitelite Satellite Open Frame Adjustable 4-3/4"Ø x 6-1/8"L x 9-3/4"Ext 90°vertical, 358° horizontal rotation	Metal Halide Par30 120v 70w Max Ballast closure: 5" x 6-5/8"	BK, WH	<b>CMMTB7030</b>	<b>LVMTB7030</b>	<b>JTMTB7030</b>	6/29lbs
	<b>MTB 7038</b> Whitelite Satellite Open Frame 5-5/8"Ø x 6-5/8"L x 10-1/4"Ext Ballast closure: 5" x 6-5/8"	Metal Halide Par38 120v 70w Max Ballast closure: 5" x 6-5/8"	BK, WH	<b>CMMTB7038</b>	<b>LVMTB7038</b>	<b>JTMTB7038</b>	6/29lbs
	<b>MTB 10038</b> Whitelite Satellite Open Frame 5-5/8"Ø x 6-5/8"L x 10-1/4"Ext 90°vertical, 358° horizontal rotation	Metal Halide Par38 120v 100w Max Ballast closure: 5" x 6-5/8"	BK, WH	<b>CMMTB10038</b>	<b>LVMTB10038</b>	<b>JTMTB10038</b>	6/29lbs
	<b>MTBL30</b> Louwer for Par30 Whitelite Satellite Open 4-1/2"Ø x 3/4"H		BK, WH	<b>MTBL30</b>	<b>MTBL30</b>	<b>MTBL30</b>	6/2lbs
	<b>MTBL38</b> Louwer for Par38 Whitelite Satellite Open 5-1/2"Ø x 1"H		BK, WH	<b>MTBL38</b>	<b>MTBL38</b>	<b>MTBL38</b>	6/2lbs

### Finish Key:

BK: Black  
 WH: White

### Ordering Instructions:

SYSTEM	MODEL	-	FINISH
--------	-------	---	--------

### Example:

Model MTA3530 in the CM system in Black

CMMTA3530-BK

## TRACK LIGHTING – COMPACT FLUORESCENT TRACK FIXTURES

Superior Performance enhanced by energy efficient, long-life, silent electronic ballasts provide uniform illumination and superior distribution of light. Full aiming capability with 90° vertical adjustment and 358° rotation combined with your choice of either a White or Specular Chrome Louver and an optically designed aluminum reflector delivers exceptional glare control.

Compact Fluorescent Track Fixtures are furnished without lamps.

### Systems:

CM: Single circuit 3-wire system. Fixtures are compatible with any "H" systems.  
 LV: Single circuit 2-wire system. Fixtures are compatible with any "L" systems.  
 JT: Single circuit wide 2-wire system. Fixtures are compatible with any "J" systems.

### CM SYSTEM





### LV SYSTEM



### JT SYSTEM



	MODEL DESCRIPTION	LAMP TYPE MAX WATT	FINISH	CM SYSTEM	LV SYSTEM	JT SYSTEM	STD PKG PCS/WGT
	<b>BX218</b> Wall Washer with Louver 12 <sup>3</sup> / <sub>8</sub> "L x 5 <sup>3</sup> / <sub>4</sub> "W x 4 <sup>1</sup> / <sub>2</sub> "H 8 <sup>1</sup> / <sub>4</sub> "Ext	(2) 18w Twin Tube Electronic Ballast	BKBK BKCH BKWH WHBK WHCH WHWH	<b>CMBX218</b>	<b>LVBX218</b>	<b>JTBX218</b>	6/37lbs
	<b>BX240</b> Wall Washer with Louver 25 <sup>1</sup> / <sub>4</sub> "L x 5 <sup>3</sup> / <sub>4</sub> "W x 4 <sup>1</sup> / <sub>2</sub> "H 8 <sup>1</sup> / <sub>4</sub> "Ext	(2) 40w Twin Tube Electronic Ballast	BKBK BKCH BKWH WHBK WHCH WHWH	<b>CMBX240</b>	<b>LVBX240</b>	<b>JTBX240</b>	4/40lbs
	<b>BX255</b> Wall Washer with Louver 25 <sup>1</sup> / <sub>4</sub> "L x 5 <sup>3</sup> / <sub>4</sub> "W x 4 <sup>1</sup> / <sub>2</sub> "H 8 <sup>1</sup> / <sub>4</sub> "Ext	(2) 55w Twin Tube Electronic Ballast	BKBK BKCH BKWH WHBK WHCH WHWH	<b>CMBX255</b>	<b>LVBX255</b>	<b>JTBX255</b>	4/45lbs

### Finish Key – Fixtures:

BKBK: Black Fixture, Black Louver  
 BKCH: Black Fixture, Specular Chrome Louver  
 BKWH: Black Fixture, White Louver  
 WHBK: White Fixture, Black Louver  
 WHCH: White Fixture, Specular Chrome Louver  
 WHWH: White Fixture, White Louver

### Ordering Instructions:

SYSTEM	MODEL	-	FINISH
--------	-------	---	--------

### Example:

Model BX255 in the CM system, Black fixture chrome louver CMBX255-BKCH

# TRACK LIGHTING – SINGLE CIRCUIT – TRACK & ACCESSORIES

## Systems:

CM: Single circuit 3-wire system. Fixtures are compatible with any “H” systems.

LV: Single circuit 2-wire system. Fixtures are compatible with any “L” systems.

JT: Single circuit wide 2-wire system. Fixtures are compatible with any “J” systems.

## CM SYSTEM



## LV SYSTEM



## JT SYSTEM



	DESCRIPTION	FINISH	MODEL CM SYSTEM	MODEL LV SYSTEM	MODEL JT SYSTEM	STD PKG PCS/WGT
	2' Track	BK, WH ST	CM2C	TR2C  N/A	N/A	12/10lbs
	4' Track	BK, WH ST	CM4C	TR4C  N/A	N/A	12/20lbs
	6' Track	BK, WH ST	CM6C	TR6C  N/A	N/A	12/29lbs
	8' Track	BK, WH ST	CM8C	TR8C  N/A	N/A	12/38lbs
	Dead End	BK, WH ST	CMDE	DE1  N/A	N/A	12/1lbs
	Low Voltage Track Fixture Transformer Adapter 65w Transformer Adapter	BK, WH ST	PCMCA	PLVCA	PJTCA	12/3lbs
	Line Voltage Track Fixture Adapter	BK, WH ST	CMAD1	AD1	JTAD1	12/1lbs
	Canopy Plate	BK, WH ST	CP4 N/A	CP4 N/A	CP4 N/A	12/5lbs
	Canopy Plate for Sloped Ceiling	BK, WH ST	CP5 N/A	CP5 N/A	CP5 N/A	12/5lbs
	Floating Canopy	BK, WH ST	CMFC	CF1 N/A	N/A	12/7lbs
	Live End	BK, WH ST	CMLE2	LE2 N/A	N/A	12/3lbs
	Live End with BX Conduit Box	BK, WH ST	CMLE4	LE4 N/A	N/A	12/4lbs
 	Monopoint When used with a Low voltage fixture, the transformer box may protrude off the Monopoint plate.	BK, WH ST	CMP7	MP7 N/A	N/A	CM 12/4lbs LV 12/8lbs
	Mini I-Connector	BK, WH ST	CMIJ	FIJ N/A	N/A	12/1lbs
	I-Connector with Powerfeed	BK, WH ST	CMJ1	FJ1 N/A	N/A	12/4lbs
	L-Connector with Powerfeed	BK, WH ST	CMJ2	FJ2 N/A	N/A	12/4lbs

TRACK LIGHTING – SINGLE CIRCUIT – TRACK ACCESSORIES ... cont'd

**Systems:**

CM: Single circuit 3-wire system. Fixtures are compatible with any "H" systems.  
 LV: Single circuit 2-wire system. Fixtures are compatible with any "L" systems.  
 JT: Single circuit wide 2-wire system. Fixtures are compatible with any "J" systems.

**CM SYSTEM**













**LV SYSTEM**



**JT SYSTEM**



	<b>DESCRIPTION</b>	<b>FINISH</b>	<b>MODEL CM SYSTEM</b>	<b>MODEL LV SYSTEM</b>	<b>MODEL JT SYSTEM</b>	<b>STD PKG PCS/WGT</b>
	T-Connector with Powerfeed	BK, WH ST	<b>CMJ3</b>	<b>FJ3</b>  N/A	<b>N/A</b>	12/6lbs
	X-Connector with Powerfeed	BK, WH ST	<b>CMJ4</b>	<b>FJ4</b>  N/A	<b>N/A</b>	12/4lbs
	Flexible Connector with Powerfeed	BK, WH ST	<b>CMFX</b>	<b>FX</b>  N/A	<b>N/A</b>	12/6lbs
	T-Bar Clip Use 2 clips for 2' and 4' tracks; 3 clips for 6' and 8' tracks.	BK, WH	<b>TB1</b>	<b>TB1</b>	<b>TB1</b>	12/1lbs
	Power Outlet Adapter	BK, WH	<b>CMAD5</b>	<b>AD5</b>	<b>N/A</b>	12/2lbs
	Track Adapter with Hook	BK, WH	<b>CMAD1H</b>	<b>AD1H</b>	<b>N/A</b>	12/2lbs
	6' Line Cord with 2-prong plug and Switch	BK, WH	<b>LC1-S</b>	<b>LC1-S</b>	<b>LC1-S</b>	12/6lbs
	15' Line Cord with 2-prong plug and Switch	BK, WH	<b>LC1-L</b>	<b>LC1-L</b>	<b>LC1-L</b>	
	6' Line Cord with 3-prong plug	BK, WH	<b>LC3-S</b>	<b>LC3-S</b>	<b>LC3-S</b>	12/6lbs
	12' Line Cord with 3-prong plug	BK, WH	<b>LC3-L</b>	<b>LC3-L</b>	<b>LC3-L</b>	
	Track Suspension Kit – Canopy only Extension Stem sold separately	BK, WH ST	<b>SK1</b>	<b>SK1</b>	<b>SK1</b>	12/6lbs
	Track Suspension Kit – 12" Extension Stem Canopy sold separately	BK, WH ST	<b>SK2</b>	<b>SK2</b>	<b>SK2</b>	12/3lbs
	Track Suspension Kit – 18" Extension Stem Canopy sold separately	BK, WH ST	<b>SK3</b>	<b>SK3</b>	<b>SK3</b>	12/4lbs
	Track Suspension Kit – 24" Extension Stem Canopy sold separately	BK, WH ST	<b>SK4</b>	<b>SK4</b>	<b>SK4</b>	12/4lbs
	Track Suspension Kit – 36" Extension Stem Canopy sold separately	BK, WH ST	<b>SK5</b>	<b>SK5</b>	<b>SK5</b>	12/7lbs
	Track Suspension Kit – 48" Extension Stem Canopy sold separately	BK, WH ST	<b>SK6</b>	<b>SK6</b>	<b>SK6</b>	12/10lbs
	Wire Cover for Suspended Track Includes Mounting Bracket	BK, WH ST	<b>SKC</b>	<b>SKC</b>	<b>SKC</b>	12/2lbs





**Finish Key:**

BK: Black  
 ST: Satin Chrome  
 WH: White

## RECESSED LIGHTING - MINIATURE LOW VOLTAGE GLASS DOWNLIGHTS

### Features:

- The Miniature Low Voltage Glass Downlight Series is complete with a built-in housing.
- They mount quickly with tension clips.
- Fixtures are supplied with 3" socket wires.
- Lamps not included.
- May be powered with an electronic transformer – see page 48-49.

	<b>MODEL DESCRIPTION</b>	<b>DIMENSION ADJUSTABILITY</b>	<b>FINISH</b>	<b>STD PKG PCS/WGT</b>
	<b>GD8601</b> 3" Round Glass Spot With Built-in Housing Lamp: 12v 50w MR16 or 120v 50w MR16GU10	2-5/8"A x 3-7/8"Ø x 1/2"EXT Cutout: 2-1/2"Ø Housing Depth: 2-1/8"	BU, PK, WH	20/16lbs
	<b>GD8603</b> 3" Round Stepped Glass Spot With Built-in Housing Lamp: 12v 50w MR16 or 120v 50w MR16GU10	2-5/8"A x 3-7/8"Ø x 1/2"EXT Cutout: 2-1/2"Ø Housing Depth: 2-1/8"	BU, PK, WH	20/16lbs
	<b>GD8606</b> 3" Square Stepped Glass Spot With Built-in Housing Lamp: 12v 50w MR16 or 120v 50w MR16GU10	2"A x 4"Ø x 3/4"EXT Cutout: 2-1/2"Ø Housing Depth: 2-1/8"	BU, PK, WH	20/16lbs
	<b>GD8611</b> 4" Adjustable Pull Down Round Glass Spot With Built-in Housing Lamp: 12v 50w MR16 or 120v 50w MR16GU10	2-3/4"A x 4-1/2"Ø x 2-3/4"EXT Cutout: 3-3/8"Ø Housing Depth: 2-1/2"	WH	20/27lbs
	<b>GD8613</b> 4" Adjustable Pull Down Round Stepped Glass Spot With Built-in Housing Lamp: 12v 50w MR16 or 120v 50w MR16GU10	2-3/4"A x 4-1/2"Ø x 2-3/4"EXT Cutout: 3-3/8"Ø Housing Depth: 2-1/2"	BU, PK, WH	20/27lbs

### Finish Key:

BU: Blue Frosted  
PK: Pink Frosted  
WH: White Frosted

RECESSED LIGHTING – 4" LOW VOLTAGE TRIMS

	MODEL DESCRIPTION	DIMENSION ADJUSTABILITY	FINISH	STD PKG PCS/WGT
	<b>TM401</b> Step Baffle Trim Lamp: 12v 50w MR16	3-1/2"A x 5"Ø 15° adjustability from vertical	BKWH, WHWH BKBK, BKCH, BKPB, BKST WHCH, WHPB, WHST CH, PB, ST	36/21lbs
	<b>TM402</b> Specular Baffle Lamp: 12v 50w MR16	3-1/2"A x 5"Ø 15° adjustability from vertical	CHWH CHBK, CHCH, CHPB, CHST PBWH PBBK, PBCH, PBPB, PBST	36/22lbs
	<b>TM403</b> Die Cast Oval Slotted Aperture with black interior Lamp: 12v 50w MR16	2-1/8"A x 5"Ø 15° adjustability from vertical	WH CH, ST	36/28lbs
	<b>TM404</b> Wall Wash with Step Baffle Lamp: 12v 50w MR16	3-1/2"A x 5"Ø x 1/4"EXT	BKWH, WHWH BKPB, BKST, WHPB ST	36/23lbs
	<b>TM405</b> Adjustable Eyeball with Step Baffle Lamp: 12v 50w MR16	2"A x 5"Ø x 1-3/8"EXT 35° adjustability from vertical	BK, WH CH, PB, ST	36/25lbs
	<b>TM407</b> Die Cast Adjustable Lamp: 12v 50w MR16	1-7/8"A x 5"Ø x 3/4"EXT 30° adjustability from vertical	BK, WH CH, PB, ST	36/25lbs
	<b>TM408</b> Gimbal Ring Lamp: 12v 50w MR16	1-5/8"A x 4-7/8"Ø x 5/8"EXT 30° adjustability from vertical	BK, WH CH, PB, ST	36/27lbs
	<b>TM409</b> Flat Shower Trim with glass Lamp: 12v 50w MR16	3-5/8"A x 5"Ø	WH BK, CH, PB, ST	36/18lbs
	<b>TM410</b> Dropped Dish Shower Trim with Frosted opal white dropped glass Lamp: 12v 50w MR16	3-1/2"A x 5"Ø x 1"EXT	WH BK, CH, PB, ST	36/25lbs
	<b>TM411</b> Adjustable Periscope Trim Die Cast Lamp: 12v 50w MR16	1-1/4"A x 5"Ø x 2-1/2"EXT 80° adjustability from vertical	BK, WH CH, PB, ST	36/29lbs
	<b>TM412</b> Albalite Shower Trim Lamp: 12v 50w MR16	3-5/8"A x 4-1/2"Ø	WH BK, CH, PB, ST	36/23lbs
	<b>TM414</b> 2-Piece Pinhole With White Baffle Lamp: 12v 50w MR16	2"A x 4-7/8"Ø	WH ST	36/24lbs
	<b>TM426</b> Gimbal Adjustable Step Baffle Die Cast Lamp: 12v 50w MR16	2"A x 5"Ø x 5/8"EXT 30° adjustability from vertical	BKWH, WHWH BKST	36/29lbs
	<b>TM428</b> Adjustable Extended Spot Lamp: 12v 50w MR16	1-5/8"A x 5"Ø x 1-1/2"EXT 30° adjustability from vertical	BK, WH	36/22lbs







**Finish Key:**

BK:	Black	PBCH:	Polished Brass Reflector, Chrome Trim
BKBK:	Black Baffle, Black Trim	PBPB:	Polished Brass Reflector, Polished Brass Trim
BKCH:	Black Baffle, Chrome Trim	PBST:	Polished Brass Reflector, Satin Chrome Trim
BKPB:	Black Baffle, Polished Brass Trim	PBWH:	Polished Brass Reflector, White Trim
BKST:	Black Baffle, Satin Chrome Trim	PB:	Polished Brass
BKWH:	Black Baffle, White Trim	ST:	Satin Chrome
CH:	Chrome	WH:	White
CHCH:	Chrome Reflector, Chrome Trim	WHCH:	White Baffle, Chrome Trim
CHPB:	Chrome Reflector, Polished Brass Trim	WHPB:	White Baffle, Polished Brass Trim
CHST:	Chrome Reflector, Satin Chrome Trim	WHST:	White Baffle, Satin Chrome Trim
CHWH:	Chrome Reflector, White Trim	WHWH:	White Baffle, White Trim











## RECESSED LIGHTING – 4" LOW VOLTAGE HOUSINGS

### Features:

- All fixtures have thermally protected housings.
- Housings are UL Listed for damp locations.
- UL listed for feed through.
- Integral pre-wired snap-out magnetic transformers.
- For use with magnetic low voltage dimmers.
- Non IC units – keep housing 3" away from insulation.
- IC – may be covered with insulation to save energy and reduce costs.
- Adjustable socket mounting plate.
- Remodel – fast and easy installation in finished ceiling.
- Airtight housings are gasketed to prevent airflow from heating or air-conditioned spaces. All Airtight housings meet State of Washington restricted airflow requirements (WSEC code).
- Lamps not included.

	<b>MODEL DESCRIPTION</b>	<b>DIMENSION CUTOUT</b>	<b>VOLT</b>	<b>MAX WATT LAMP</b>	<b>STD PKG PCS/WGT</b>
	<b>LV4000B</b> 4" Universal Housing For New Construction	5-1/4"W x 10-1/2"L x 5-1/2"D Hanger Bars: 14-1/2" ~ 24-1/2" Cutout: 4-3/8"Ø	120v – 12v	50w MR16	6/31lbs
	<b>LV4000BA</b> 4" Airtight Universal Housing For New Construction	5-1/4"W x 10-1/2"L x 5-1/2"D Hanger Bars: 14-1/2" ~ 24-1/2" Cutout: 4-3/8"Ø	120v – 12v	50w MR16	6/31lbs
	<b>LV4000IC</b> 4" IC Housing For New Construction	5-3/4"W x 8"L x 6-1/2"D Hanger Bars: 14-1/2" ~ 24-1/2" Cutout: 4-3/8"Ø	120v – 12v	50w MR16	4/27lbs
	<b>LV4000ICA</b> 4" Airtight IC Housing For New Construction	5-3/4"W x 8"L x 6-1/2"D Hanger Bars: 14-1/2" ~ 24-1/2" Cutout: 4-3/8"Ø	120v – 12v	50w MR16	4/27lbs
	<b>LV4000R</b> 4" Housing For Remodeling	4-5/8"W x 14-1/2"L x 5-3/4"D Cutout: 4-3/8"Ø	120v – 12v	50w MR16	6/25lbs
	<b>LV4000RA</b> 4" Airtight Housing For Remodeling	4-5/8"W x 14-1/2"L x 5-3/4"D Cutout: 4-3/8"Ø	120v – 12v	50w MR16	6/25lbs

## RECESSED LIGHTING – 4" LINE VOLTAGE TRIMS

	<b>MODEL DESCRIPTION</b>	<b>DIMENSION ADJUSTABILITY</b>	<b>FINISH</b>	<b>STD PKG PCS/WGT</b>
	<b>TM201</b> Stepped Baffled Trim Lamp: Par16, Par 20 – 50w max	3-3/8" A x 5" Ø	BKWH, WHWH BKBK, BKCH, BKPB, BKST WHCH, WHPB, WHST CH, PB, ST	36/21lbs
	<b>TM202</b> Specular Reflector Lamp: Par16, Par 20 – 50w max	3-3/8" A x 5" Ø	CHWH CHBK, CHCH, CHPB, CHST PBWH PBBK, PBCH, PBPB, PBST	36/18lbs
	<b>TM203</b> Die Cast Oval Slotted Aperture (2-piece face) Lamp: Par16, Par 20 – 50w max	3-1/2" A x 5" Ø	WH CH, ST	36/18lbs
	<b>TM204</b> Wall Wash with Baffle Lamp: Par16, Par 20 – 50w max	3-1/2" A x 5" Ø x 1-1/8" EXT 35° adjustability from vertical	BKWH, WHWH BKPB, BKST, WHPB ST	36/18lbs
	<b>TM205</b> Adjustable Eyeball Lamp: Par16, Par 20 – 50w max	2-3/4" A x 5" Ø x 1" EXT 35° adjustability from vertical	WH, BK CH, PB, ST	36/25lbs
	<b>TM208</b> Adjustable Gimbal Ring Lamp: Par16, Par 20 – 50w max	2-1/4" A x 5" Ø x 7/8" EXT 30° adjustability from vertical	BK, WH CH, PB, ST	36/23lbs
	<b>TM209</b> Flat Shower Trim Frosted opal white glass Lamp: Par16, Par 20 – 50w max	3-5/8" A x 5" Ø	WH BK, CH, PB, ST	36/18lbs
	<b>TM210</b> Dropped Dish Shower Trim Frosted Opal White Glass Lamp: Par16, Par 20 – 50w max	3-3/8" A x 5" Ø x 1" EXT	WH BK, CH, PB, ST	36/19lbs
	<b>TM212</b> Albalite Shower Trim Lamp: Par16, Par 20 – 50w max	3-5/8" A x 5" Ø	WH BK, CH, PB, ST	36/18lbs
	<b>TM214</b> 2-Piece Pinhole With White Baffle Lamp: Par16, Par 20 – 50w max	3-1/2" A x 5" Ø	WH ST	36/18lbs







### Finish Key:

BK:	Black	PBCH:	Polished Brass Reflector, Chrome Trim
BKBK:	Black Baffle, Black Trim	PBPB:	Polished Brass Reflector, Polished Brass Trim
BKCH:	Black Baffle, Chrome Trim	PBST:	Polished Brass Reflector, Satin Chrome Trim
BKPB:	Black Baffle, Polished Brass Trim	PBWH:	Polished Brass Reflector, White Trim
BKST:	Black Baffle, Satin Chrome Trim	PB:	Polished Brass
BKWH:	Black Baffle, White Trim	ST:	Satin Chrome
CH:	Chrome	WH:	White
CHCH:	Chrome Reflector, Chrome Trim	WHCH:	White Baffle, Chrome Trim
CHPB:	Chrome Reflector, Polished Brass Trim	WHPB:	White Baffle, Polished Brass Trim
CHST:	Chrome Reflector, Satin Chrome Trim	WHST:	White Baffle, Satin Chrome Trim
CHWH:	Chrome Reflector, White Trim	WHWH:	White Baffle, White Trim











## RECESSED LIGHTING – 4" LINE VOLTAGE HOUSINGS

### Features:

- All fixtures have thermally protected housings.
- UL Listed for damp locations.
- UL Listed for feed through.
- Non IC units – keep housing 3" away from insulation.
- IC – may be covered with insulation to save energy and reduce costs.
- Adjustable socket mounting plate.
- Remodel – fast and easy installation in finished ceiling.
- Airtight housings are gasketed to prevent airflow from heating or air-conditioned spaces. All Airtight housings meet State of Washington restricted airflow requirements (WSEC code).
- Line Voltage fixtures are available for R16, R20, Par20, A19 (not included); or 120v 50w MR16 GU10 Twist and Lock Line Voltage Lamps. When using Line Voltage 120v 50w MR16 GU10 lamps, an adapting cable is required – order part number AC-E26/GU10.

	<b>MODEL DESCRIPTION</b>	<b>DIMENSION CUTOUT</b>	<b>VOLT</b>	<b>MAX WATT</b>	<b>STD PKG PCS/WGT</b>
	<b>RS2000B</b> 4" Universal Housing For New Construction	5-1/4" W x 8" L x 5-1/2" D Hanger Bars: 14-1/2" ~ 24-1/2" Cutout: 4-3/8" Ø	120v	50w	6/19lbs
	<b>RS2000BA</b> 4" Airtight Universal Housing For New Construction	5-1/4" W x 8" L x 5-1/2" D Hanger Bars: 14-1/2" ~ 24-1/2" Cutout: 4-3/8" Ø	120v	50w	6/11lbs
	<b>RS2000IC</b> 4" IC Housing For New Construction	5-1/4" W x 8" L x 6" D Hanger Bars: 14-1/2" ~ 24-1/2" Cutout: 4-3/8" Ø	120v	50w	6/21lbs
	<b>RS2000ICA</b> 4" Airtight IC Housing For New Construction	5-1/4" W x 8" L x 6" D Hanger Bars: 14-1/2" ~ 24-1/2" Cutout: 4-3/8" Ø	120v	50w	6/21lbs
	<b>RS2000R</b> 4" Housing For Remodeling	4-5/8" W x 12" L x 5-1/2" D Cutout: 4-3/8" Ø	120v	50w	6/13lbs
	<b>RS2000RA</b> 4" Airtight Housing For Remodeling	4-5/8" W x 12" L x 5-1/2" D Cutout: 4-3/8" Ø	120v	50w	6/13lbs
	<b>AC-E26/GU10</b> Adapting cable for 120v 50w MR16 GU10 lamps.				6/3lbs

RECESSED LIGHTING – 4" METAL HALIDE TRIMS

	<b>MODEL DESCRIPTION</b>	<b>DIMENSION ADJUSTABILITY</b>	<b>FINISH</b>	<b>STD PKG PCS/WGT</b>
	<b>TM201</b> Stepped Baffled Trim Lamp: MH Par16, Par 20 – 39w	3-3/8" A x 5" Ø	BKWH, WHWH BKBK, BKCH, BKPB, BKST WHCH, WHPB, WHST CH, PB, ST	36/21lbs
	<b>TM202</b> Specular Reflector Lamp: Par16, Par 20 – 50w max	3-3/8" A x 5" Ø	CHWH CHBK, CHCH, CHPB, CHST PBWH PBBK, PBCH, PBPB, PBST	36/18lbs
	<b>TM203</b> Die Cast Oval Slotted Aperture (2-piece face) Lamp: Par16, Par 20 – 50w max	3-1/2" A x 5" Ø	WH CH, ST	36/18lbs
	<b>TM204</b> Wall Wash with Baffle Lamp: Par16, Par 20 – 50w max	3-1/2" A x 5" Ø x 1-1/8" EXT 35° adjustability from vertical	BKWH, WHWH BKPB, BKST, WHPB ST	36/18lbs
	<b>TM205</b> Adjustable Eyeball Lamp: Par16, Par 20 – 50w max	2-3/4" A x 5" Ø x 1" EXT 35° adjustability from vertical	WH, BK CH, PB, ST	36/25lbs
	<b>TM208</b> Adjustable Gimbal Ring Lamp: Par16, Par 20 – 50w max	2-1/4" A x 5" Ø x 7/8" EXT 30° adjustability from vertical	BK, WH CH, PB, ST	36/23lbs
	<b>TM209</b> Flat Shower Trim Frosted opal white glass Lamp: Par16, Par 20 – 50w max	3-5/8" A x 5" Ø	WH BK, CH, PB, ST	36/18lbs
	<b>TM210</b> Dropped Dish Shower Trim Frosted Opal White Glass Lamp: Par16, Par 20 – 50w max	3-3/8" A x 5" Ø x 1" EXT	WH BK, CH, PB, ST	36/19lbs
	<b>TM212</b> Albalite Shower Trim Lamp: Par16, Par 20 – 50w max	3-5/8" A x 5" Ø	WH BK, CH, PB, ST	36/18lbs
	<b>TM214</b> 2-Piece Pinhole With White Baffle Lamp: Par16, Par 20 – 50w max	3-1/2" A x 5" Ø	WH ST	36/18lbs



**Finish Key:**

BK:	Black	PBCH:	Polished Brass Reflector, Chrome Trim
BKBK:	Black Baffle, Black Trim	PBPB:	Polished Brass Reflector, Polished Brass Trim
BKCH:	Black Baffle, Chrome Trim	PBST:	Polished Brass Reflector, Satin Chrome Trim
BKPB:	Black Baffle, Polished Brass Trim	PBWH:	Polished Brass Reflector, White Trim
BKST:	Black Baffle, Satin Chrome Trim	PB:	Polished Brass
BKWH:	Black Baffle, White Trim	ST:	Satin Chrome
CH:	Chrome	WH:	White
CHCH:	Chrome Reflector, Chrome Trim	WHCH:	White Baffle, Chrome Trim
CHPB:	Chrome Reflector, Polished Brass Trim	WHPB:	White Baffle, Polished Brass Trim
CHST:	Chrome Reflector, Satin Chrome Trim	WHST:	White Baffle, Satin Chrome Trim
CHWH:	Chrome Reflector, White Trim	WHWH:	White Baffle, White Trim

## RECESSED LIGHTING – 4" METAL HALIDE HOUSINGS

### Features:

- All fixtures have thermally protected housings.
- UL Listed for damp locations.
- UL Listed for feed through.
- Non IC units – keep housing 3" away from insulation.
- Adjustable socket mounting plate.
- Remodel – fast and easy installation in finished ceiling.
- Medium base porcelain socket.

	MODEL DESCRIPTION	DIMENSION CUTOUT	VOLT	MAX WATT	STD PKG PCS/WGT
<b>4" MH Housing for New Construction</b>					
	<b>MH40B-35-E1</b>	5-1/4" W x 8" L x 5-1/2" D Hanger Bars: 14-1/2" ~ 24-1/2" Cutout: 4-3/8" Ø	120v Electronic	39w MH Par 20	6/21lbs
	<b>MH40B-35-E2</b>	5-1/4" W x 8" L x 5-1/2" D Hanger Bars: 14-1/2" ~ 24-1/2" Cutout: 4-3/8" Ø	277v Electronic	39w MH Par 20	6/21lbs
<b>4" MH Housing for Remodeling</b>					
	<b>MH40R-35-E1</b>	4-5/8" W x 12" L x 5-1/2" D Cutout: 4-3/8" Ø	120v Electronic	39w MH Par 20	6/15lbs
	<b>MH40R-35-E2</b>	4-5/8" W x 12" L x 5-1/2" D Cutout: 4-3/8" Ø	277v Electronic	39w MH Par 20	6/15lbs



RECESSED LIGHTING – 6" LINE VOLTAGE TRIMS

	<b>MODEL DESCRIPTION</b>	<b>DIMENSION ADJUSTABILITY</b>	<b>FINISH</b>	<b>STD PKG PCS/WGT</b>
	<b>TM501</b> Open Trim Ring (38) Lamp: Par38, R40 – 150w max	5-1/8" A x 7-7/8" Ø	BK, WH CH, PB	24/13lbs
	<b>TM502</b> Open Trim Ring (30) Lamp: Par30, R30 – 100w max	3-7/8" A x 7-7/8" Ø	WH	24/10lbs
	<b>TM503*</b> Adjustable Gimbal Ring Lamp: Par30, R30 – 100w max	3-1/4" A x 8" Ø x 1-3/4" EXT 30° adjustability from vertical	WH CH, PB, ST	24/20lbs
	<b>TM504*</b> Adjustable Gimbal Ring Lamp: Par38, R40 – 150w max	4-1/4" A x 8" Ø x 1-1/8" EXT 30° adjustability from vertical	WH CH, PB, ST	24/19lbs
	<b>TM505</b> Dropped Dish Shower Trim Frosted opal white dropped glass Lamp: A19 – 75w max	5" A x 8" Ø x 1-1/8" EXT	WH	24/11lbs
	<b>TM507</b> Fresnel Glass Lens Lamp: Par30, R30 – 100w max	3-1/2" A x 7-5/8" Ø	WH	24/10lbs
	<b>TM508</b> Step Baffled Trim Lamp: Par38, R40 – 150w max	5-3/4" A x 7-7/8" Ø	BKWH, WHWH BKBK, BKCH, BKPB, BKST WHCH, WHPB, WHST	24/14lbs
	<b>TM509</b> Step Baffled Trim Lamp: Par30, R30 – 100w max	5-5/8" A x 7-7/8" Ø	BKWH, WHWH BKBK, BKCH, BKPB, BKST WHCH, WHPB, WHST ST	24/12lbs
	<b>TM510</b> Specular Baffle Lamp: Par30, R30 – 100w max	5-5/8" A x 7-7/8" Ø	CHWH CHCH, CHPB, CHST PBWH PBCH, PBPB, PBST	24/18lbs
	<b>TM513*</b> Eyeball Lamp: Par30, R30 – 100w max	4" A x 8-1/8" Ø x 2-1/4" EXT 25° adjustability from vertical	BK, WH CH, PB, ST	24/32lbs
	<b>TM514**</b> Specular Reflector/Step Baffle Lamp: Par30, R30 – 100w max	5-5/8" A x 7-5/8" Ø	BKWH, WHWH BKBK, BKCH, BKPB, BKST WHBK, WHCH, WHPB, WHST	24/24lbs
	<b>TM515</b> The Energy Saver (Air tight) Adaptable to jacketed self-ballasted fluorescent lamps Lamp: Par30, R30 – 100w max	3-1/2" A x 5-1/2" Ø	WH CHWH	24/24lbs
	<b>TM516</b> Flat Opal Glass Lamp: A19 – 75w max	5-1/8" A x 8-1/4" Ø	WH	24/18lbs
	<b>TM518*</b> Regressed Eyeball Lamp: Par30, R30 – 100w max	4" A x 7-3/8" Ø x 1-1/4" EXT 25° adjustability from vertical	WH	24/38lbs
	<b>TM521</b> Pinhole Lamp: Par16 – 75w max	1-7/8" A x 8-1/8" Ø	WH	24/36lbs

\*Trims TM503, TM504, TM513 and TM518 – Remove socket holder plate from the housing before installing trim.

\*\*TM514 will not fit the shallow housings.

RECESSED LIGHTING - 6" LINE VOLTAGE TRIMS ... cont'd

	<b>MODEL DESCRIPTION</b>	<b>DIMENSION ADJUSTABILITY</b>	<b>FINISH</b>	<b>STD PKG PCS/WGT</b>
	<b>TM529</b> Wall Wash with Step Baffle	5-5/8" A x 7-5/8" Ø	BKWH, WHWH	24/16lbs
	Lamp: Par30, R30 - 100w max			
	<b>TM530</b> Wall Wash with Reflector	5-5/8" A x 7-5/8" Ø	CHWH, PBWH	24/16lbs
	Lamp: Par30, R30 - 100w max			











**Finish Key:**

BK:	Black	PB:	Polished Brass
BKBK:	Black Baffle, Black Trim	PBCH:	Polished Brass Reflector, Chrome Trim
BKCH:	Black Baffle, Chrome Trim	PBPB:	Polished Brass Reflector, Polished Brass Trim
BKPB:	Black Baffle, Polished Brass Trim	PBST:	Polished Brass Reflector, Satin Chrome Trim
BKST:	Black Baffle, Satin Chrome Trim	PBWH:	Polished Brass Reflector, White Trim
BKWH:	Black Baffle, White Trim	ST:	Satin Chrome
CH:	Chrome	WH:	White
CHCH:	Chrome Reflector, Chrome Trim	WHCH:	White Baffle, Chrome Trim
CHPB:	Chrome Reflector, Polished Brass Trim	WHPB:	White Baffle, Polished Brass Trim
CHST:	Chrome Reflector, Satin Chrome Trim	WHST:	White Baffle, Satin Chrome Trim
CHWH:	Chrome Reflector, White Trim	WHWH:	White Baffle, White Trim









## RECESSED LIGHTING – 6" LINE VOLTAGE HOUSINGS

### Features:

- All fixtures have thermally protected housings.
- UL Listed for damp locations.
- UL Listed for feed through.
- For use with incandescent dimmers.
- Non IC units – keep housing 3" away from insulation.
- IC – may be covered with insulation to save energy and reduce costs.
- Adjustable socket mounting plate.
- Remodel – fast and easy installation in finished ceiling.
- Airtight housings are gasketed to prevent airflow from heating or air-conditioned spaces. All Airtight housings meet State of Washington restricted airflow requirements (WSEC code).
- Lamps not included.

	<b>MODEL DESCRIPTION</b>	<b>DIMENSION CUTOUT</b>	<b>VOLT</b>	<b>MAX WATT</b>	<b>STD PKG PCS/WGT</b>
	<b>RS5000B</b> 6" Universal Housing For New Construction	7" W x 10-1/4" L x 7-5/8" D Hanger Bars: 14-1/2" ~ 24-1/2" Cutout: 6-3/8" Ø	120v	150w	6/27lbs
	<b>RS5000BA</b> 6" Airtight Universal Housing For New Construction	7" W x 10-1/4" L x 7-5/8" D Hanger Bars: 14-1/2" ~ 24-1/2" Cutout: 6-3/8" Ø	120v	150w	6/27lbs
	<b>RS5000BIC</b> 6" IC Housing For New Construction	7" W x 10-1/4" L x 7-5/8" D Hanger Bars: 14-1/2" ~ 24-1/2" Cutout: 6-3/8" Ø	120v	75w	6/20lbs
	<b>RS5000BICA</b> 6" Airtight IC Housing For New Construction	7" W x 10-1/4" L x 7-5/8" D Hanger Bars: 14-1/2" ~ 24-1/2" Cutout: 6-3/8" Ø	120v	100w	6/20lbs
	<b>RS5000S</b> 6" Shallow Housing For New Construction	7" W x 10-1/4" L x 5-1/2" D Hanger Bars: 14-1/2" ~ 24-1/2" Cutout: 6-3/8" Ø	120v	150w	6/25lbs
	<b>RS5000R</b> 6" Housing For Remodeling	6-7/8" W x 13-1/2" L x 7-3/4" D Cutout: 6-1/2" Ø	120v	150w	6/20lbs
	<b>RS5000RA</b> 6" Airtight Housing For Remodeling	6-7/8" W x 13-1/2" L x 7-3/4" D Cutout: 6-1/2" Ø	120v	150w	6/20lbs
	<b>RS5000RIC</b> 6" IC Housing For Remodeling	6-7/8" W x 13-1/2" L x 7-3/4" D Cutout: 6-1/2" Ø	120v	100w	6/16lbs
	<b>RS5000RICA</b> 6" Airtight IC Housing For Remodeling	6-7/8" W x 13-1/2" L x 7-3/4" D Cutout: 6-1/2" Ø	120v	100w	6/16lbs
	<b>RS5000SR</b> 6" Shallow Housing For Remodeling	7" W x 12" L x 5-1/2" D Cutout: 6-5/8" Ø	120v	150w	6/14lbs

RECESSED LIGHTING – 6" COMMERCIAL METAL HALIDE TRIMS

	<b>MODEL DESCRIPTION</b>	<b>DIMENSION ADJUSTABILITY</b>	<b>FINISH</b>	<b>STD PKG PCS/WGT</b>
	<b>TM501</b> Open Trim Ring (38) Lamp: Par38, R40 – 150w max	5-1/8" A x 7-7/8" Ø	BK, WH CH, PB	24/13lbs
	<b>TM502</b> Open Trim Ring (30) Lamp: Par30, R30 – 100w max	3-7/8" A x 7-7/8" Ø	WH	24/10lbs
	<b>TM508</b> Step Baffled Trim Lamp: Par38, R40 – 150w max	5-3/4" A x 7-7/8" Ø	BKWH, WHWH BKBK, BKCH, BKPB, BKST WHCH, WHPB, WHST	24/14lbs
	<b>TM509</b> Step Baffled Trim Lamp: Par30, R30 – 100w max	5-5/8" A x 7-7/8" Ø	BKWH, WHWH BKBK, BKCH, BKPB, BKST WHCH, WHPB, WHST ST	24/12lbs
	<b>TM510</b> Specular Baffle Lamp: Par30, R30 – 100w max	5-5/8" A x 7-7/8" Ø	CHWH CHCH, CHPB, CHST PBWH PBCH, PBPB, PBST	24/18lbs
	<b>TM513</b> Eyeball Lamp: Par30, R30 – 100w max	4" A x 8-1/8" Ø x 2-1/4" EXT 25° adjustability from vertical	BK, WH CH, PB, ST	24/32lbs
	<b>TM514</b> Specular Reflector/Step Baffle Lamp: Par30, R30 – 100w max	5-5/8" A x 7-5/8" Ø	BKWH, WHWH BKBK, BKCH, BKPB, BKST WHBK, WHCH, WHPB, WHST	24/24lbs
	<b>TM529</b> Wall Wash with Step Baffle Lamp: Par30, R30 – 100w max	5-5/8" A x 7-5/8" Ø	BKWH, WHWH	24/16lbs
	<b>TM530</b> Wall Wash with Reflector Lamp: Par30, R30 – 100w max	5-5/8" A x 7-5/8" Ø	CHWH, PBWH	24/16lbs

**Finish Key:**

BK:	Black	PB:	Polished Brass
BKBK:	Black Baffle, Black Trim	PBCH:	Polished Brass Reflector, Chrome Trim
BKCH:	Black Baffle, Chrome Trim	PBPB:	Polished Brass Reflector, Polished Brass Trim
BKPB:	Black Baffle, Polished Brass Trim	PBST:	Polished Brass Reflector, Satin Chrome Trim
BKST:	Black Baffle, Satin Chrome Trim	PBWH:	Polished Brass Reflector, White Trim
BKWH:	Black Baffle, White Trim	ST:	Satin Chrome
CH:	Chrome	WH:	White
CHCH:	Chrome Reflector, Chrome Trim	WHCH:	White Baffle, Chrome Trim
CHPB:	Chrome Reflector, Polished Brass Trim	WHPB:	White Baffle, Polished Brass Trim
CHST:	Chrome Reflector, Satin Chrome Trim	WHST:	White Baffle, Satin Chrome Trim
CHWH:	Chrome Reflector, White Trim	WHWH:	White Baffle, White Trim







\*Note:  
Trim TM513 – Remove socket holder plate from the housing before installing trim.

## RECESSED LIGHTING – 6" COMMERCIAL METAL HALIDE HOUSINGS









New Construction and Remodeling Housings furnished with superior grade Class "P" Thermally Protected Solid State Electronic Ballasts. (Perfect compatibility when used with MasterColor™ and other Ceramic Arc Metal Halide Par30 and Par38 lamps).

### Features:

- All fixtures have thermally protected housings.
- UL Listed for damp locations.
- UL Listed for feed through.
- Non IC units – keep housing 3" away from insulation.
- IC – may be covered with insulation to save energy and reduce costs.
- Adjustable socket mounting plate.
- Remodel – fast and easy installation in finished ceiling.
- Airtight housings are gasketed to prevent airflow from heating or air-conditioned spaces. All Airtight housings meet State of Washington restricted airflow requirements (WSEC code).
- Lamps not included.

	MODEL DESCRIPTION	DIMENSION CUTOUT	VOLT	MAX WATT	STD PKG PCS/WGT
<b>6" MH Housing for New Construction</b>					
	<b>MH60B-35-E1</b>	7" W x 10-1/4" L x 7-5/8" D Hanger Bars: 14-1/2" ~ 24-1/2" Cutout: 6-3/8" Ø	120v Electronic	35w Par20, Par30L	6/27lbs
	<b>MH60B-35-E2</b>	7" W x 10-1/4" L x 7-5/8" D Hanger Bars: 14-1/2" ~ 24-1/2" Cutout: 6-3/8" Ø	277v Electronic	35w Par20, Par30L	6/27lbs
	<b>MH60B-70-E1</b>	7" W x 10-1/4" L x 7-5/8" D Hanger Bars: 14-1/2" ~ 24-1/2" Cutout: 6-3/8" Ø	120v Electronic	70w ED17, Par30L, Par38	6/27lbs
	<b>MH60B-70-E2</b>	7" W x 10-1/4" L x 7-5/8" D Hanger Bars: 14-1/2" ~ 24-1/2" Cutout: 6-3/8" Ø	277v Electronic	70w ED17, Par30L, Par38	6/27lbs
	<b>MH60B-100-E1</b>	7" W x 10-1/4" L x 7-5/8" D Hanger Bars: 14-1/2" ~ 24-1/2" Cutout: 6-3/8" Ø	120v Electronic	100w ED17, Par38	6/27lbs
	<b>MH60B-100-E2</b>	7" W x 10-1/4" L x 7-5/8" D Hanger Bars: 14-1/2" ~ 24-1/2" Cutout: 6-3/8" Ø	277v Electronic	100w ED17, Par38	6/27lbs
<b>6" MH Airtight Housing for New Construction</b>					
	<b>MH60BA-35-E1</b>	7" W x 10-1/4" L x 7-5/8" D Hanger Bars: 14-1/2" ~ 24-1/2" Cutout: 6-3/8" Ø	120v Electronic	35w Par20, Par30L	6/27lbs
	<b>MH60BA-35-E2</b>	7" W x 10-1/4" L x 7-5/8" D Hanger Bars: 14-1/2" ~ 24-1/2" Cutout: 6-3/8" Ø	277v Electronic	35w Par20, Par30L	6/27lbs
	<b>MH60BA-70-E1</b>	7" W x 10-1/4" L x 7-5/8" D Hanger Bars: 14-1/2" ~ 24-1/2" Cutout: 6-3/8" Ø	120v Electronic	70w ED17, Par30L, Par38	6/27lbs
	<b>MH60BA-70-E2</b>	7" W x 10-1/4" L x 7-5/8" D Hanger Bars: 14-1/2" ~ 24-1/2" Cutout: 6-3/8" Ø	277v Electronic	70w ED17, Par30L, Par38	6/27lbs
	<b>MH60BA-100-E1</b>	7" W x 10-1/4" L x 7-5/8" D Hanger Bars: 14-1/2" ~ 24-1/2" Cutout: 6-3/8" Ø	120v Electronic	100w ED17, Par38	6/27lbs
	<b>MH60BA-100-E2</b>	7" W x 10-1/4" L x 7-5/8" D Hanger Bars: 14-1/2" ~ 24-1/2" Cutout: 6-3/8" Ø	277v Electronic	100w ED17, Par38	6/27lbs

RECESSED LIGHTING - 6" COMMERCIAL METAL HALIDE HOUSINGS ... cont'd

	MODEL DESCRIPTION	DIMENSION CUTOUT	VOLT	MAX WATT	STD PKG PCS/WGT
<b>6" MH IC Housing for New Construction</b>					
	MH60BIC-35-E1	7" W x 10-1/4" L x 7-5/8" D Hanger Bars: 14-1/2" ~ 24-1/2" Cutout: 6-3/8" Ø	120v Electronic	35w Par20, Par30L	6/20lbs
	MH60BIC-35-E2	7" W x 10-1/4" L x 7-5/8" D Hanger Bars: 14-1/2" ~ 24-1/2" Cutout: 6-3/8" Ø	277v Electronic	35w Par20, Par30L	6/20lbs
	MH60BIC-70-E1	7" W x 10-1/4" L x 7-5/8" D Hanger Bars: 14-1/2" ~ 24-1/2" Cutout: 6-3/8" Ø	120v Electronic	70w ED17, Par30L, Par38	6/20lbs
	MH60BIC-70-E2	7" W x 10-1/4" L x 7-5/8" D Hanger Bars: 14-1/2" ~ 24-1/2" Cutout: 6-3/8" Ø	277v Electronic	70w ED17, Par30L, Par38	6/20lbs
	MH60BIC-100-E1	7" W x 10-1/4" L x 7-5/8" D Hanger Bars: 14-1/2" ~ 24-1/2" Cutout: 6-3/8" Ø	120v Electronic	100w ED17, Par38	6/20lbs
	MH60BIC-100-E2	7" W x 10-1/4" L x 7-5/8" D Hanger Bars: 14-1/2" ~ 24-1/2" Cutout: 6-3/8" Ø	277v Electronic	100w ED17, Par38	6/20lbs
<b>6" MH Housing for Remodeling</b>					
	MH60R-35-E1	6-7/8" W x 13-1/2" L x 7-3/4" D Cutout: 6-1/2" Ø	120v Electronic	35w Par20, Par30L	6/20lbs
	MH60R-35-E2	6-7/8" W x 13-1/2" L x 7-3/4" D Cutout: 6-1/2" Ø	277v Electronic	35w Par20, Par30L	6/20lbs
	MH60R-70-E1	6-7/8" W x 13-1/2" L x 7-3/4" D Cutout: 6-1/2" Ø	120v Electronic	70w ED17, Par30L, Par38	6/20lbs
	MH60R-70-E2	6-7/8" W x 13-1/2" L x 7-3/4" D Cutout: 6-1/2" Ø	277v Electronic	70w ED17, Par30L, Par38	6/20lbs
	MH60R-100-E1	6-7/8" W x 13-1/2" L x 7-3/4" D Cutout: 6-1/2" Ø	120v Electronic	100w ED17, Par38	6/20lbs
	MH60R-100-E2	6-7/8" W x 13-1/2" L x 7-3/4" D Cutout: 6-1/2" Ø	277v Electronic	100w ED17, Par38	6/20lbs
<b>6" MH Airtight Housing for Remodeling</b>					
	MH60RA-35-E1	6-7/8" W x 13-1/2" L x 7-3/4" D Cutout: 6-1/2" Ø	120v Electronic	35w Par20, Par30L	6/20lbs
	MH60RA-35-E2	6-7/8" W x 13-1/2" L x 7-3/4" D Cutout: 6-1/2" Ø	277v Electronic	35w Par20, Par30L	6/20lbs
	MH60RA-70-E1	6-7/8" W x 13-1/2" L x 7-3/4" D Cutout: 6-1/2" Ø	120v Electronic	70w ED17, Par30L, Par38	6/20lbs
	MH60RA-70-E2	6-7/8" W x 13-1/2" L x 7-3/4" D Cutout: 6-1/2" Ø	277v Electronic	70w ED17, Par30L, Par38	6/20lbs
	MH60RA-100-E1	6-7/8" W x 13-1/2" L x 7-3/4" D Cutout: 6-1/2" Ø	120v Electronic	100w ED17, Par38	6/20lbs
	MH60RA-100-E2	6-7/8" W x 13-1/2" L x 7-3/4" D Cutout: 6-1/2" Ø	277v Electronic	100w ED17, Par38	6/20lbs

RECESSED LIGHTING – 8" COMMERCIAL HORIZONTAL COMPACT FLUORESCENT TRIMS











	MODEL DESCRIPTION	DIMENSION ADJUSTABILITY	FINISH	STD PKG PCS/WGT
	<b>TM890</b> Open Reflector	7-1/4" A x 9-1/2"Ø	CHWH, GDWH CHST, GDST	6/6lbs

Finish Key:  
 CHST: Specular Reflector, Satin Chrome Trim  
 CHWH: Specular Reflector, White Trim  
 GDST: Specular Gold, Satin Chrome Trim  
 GDWH: Specular Gold, White Trim

RECESSED LIGHTING – 8" COMMERCIAL HORIZONTAL COMPACT FLUORESCENT HOUSINGS







Features:

- All fixtures have thermally protected housings.
- UL Listed for damp locations.
- UL Listed for feed through.
- Non IC units – keep housing 3" away from insulation.
- Adjustable bar hangers up to 24".
- Lamps not included.

	MODEL DESCRIPTION	DIMENSION CUTOUT	VOLT	MAX WATT LAMP	STD PKG PCS/WGT
	<b>CFH80C-109-M1</b> 8" Horizontal Mounting Frame	14-1/2" W x 13-1/2"L x 6"D Cutout: 7-7/8" Ø	120v HPF Magnetic	(1) 7w or 9w Twin 4-Pin	1/6lbs
	<b>CFH80C-109-M2</b> 8" Horizontal Mounting Frame	14-1/2" W x 13-1/2"L x 6"D Cutout: 7-7/8" Ø	277v HPF Magnetic	(1) 7w or 9w Twin 4-Pin	1/6lbs
	<b>CFH80C-209-M1</b> 8" Horizontal Mounting Frame	14-1/2" W x 13-1/2"L x 6"D Cutout: 7-7/8" Ø	120v HPF Magnetic	(2) 7w or 9w Twin 4-Pin	1/6lbs
	<b>CFH80C-209-M2</b> 8" Horizontal Mounting Frame	14-1/2" W x 13-1/2"L x 6"D Cutout: 7-7/8" Ø	277v HPF Magnetic	(2) 7w or 9w Twin 4-Pin	1/6lbs
	<b>CFH80C-113-E</b> 8" Horizontal Mounting Frame	14-1/2" W x 13-1/2"L x 6"D Cutout: 7-7/8" Ø	120v/277v HPF Electronic	(1) 13w Twin/Quad 4-Pin	1/6lbs
	<b>CFH80C-213-E</b> 8" Horizontal Mounting Frame	14-1/2" W x 13-1/2"L x 6"D Cutout: 7-7/8" Ø	120v/277v HPF Electronic	(2) 13w Twin/Quad 4-Pin	1/6lbs
	<b>CFH80C-118-E</b> 8" Horizontal Mounting Frame	14-1/2" W x 13-1/2"L x 6"D Cutout: 7-7/8" Ø	120v/277v HPF Electronic	(1) 18w Quad 4-Pin	1/6lbs
	<b>CFH80C-218-E</b> 8" Horizontal Mounting Frame	14-1/2" W x 13-1/2"L x 6"D Cutout: 7-7/8" Ø	120v/277v HPF Electronic	(2) 18w Quad 4-Pin	1/6lbs
	<b>CFH80C-126-E</b> 8" Horizontal Mounting Frame	14-1/2" W x 13-1/2"L x 6"D Cutout: 7-7/8" Ø	120v/277v HPF Electronic	(1) 26w Quad 4-Pin	1/6lbs
	<b>CFH80C-226-E</b> 8" Horizontal Mounting Frame	14-1/2" W x 13-1/2"L x 6"D Cutout: 7-7/8" Ø	120v/277v HPF Electronic	(2) 26w Quad 4-Pin	1/6lbs

RECESSED LIGHTING - 8" COMMERCIAL HORIZONTAL COMPACT FLUORESCENT HOUSINGS ...

cont'd

	<b>MODEL DESCRIPTION</b>	<b>DIMENSION CUTOUT</b>	<b>VOLT</b>	<b>MAX WATT LAMP</b>	<b>STD PKG PCS/WGT</b>
	<b>CFH80C-113T-E</b> 8" Horizontal Mounting Frame	14-1/2" W x 13-1/2"L x 6"D Cutout: 7-7/8" Ø	120v/277v HPF Electronic	(1) 13w Triple Biax 4-Pin	1/6lbs
	<b>CFH80C-213T-E</b> 8" Horizontal Mounting Frame	14-1/2" W x 13-1/2"L x 6"D Cutout: 7-7/8" Ø	120v/277v HPF Electronic	(2) 13w Triple Biax 4-Pin	1/6lbs
	<b>CFH80C-118T-E</b> 8" Horizontal Mounting Frame	14-1/2" W x 13-1/2"L x 6"D Cutout: 7-7/8" Ø	120v/277v HPF Electronic	(1) 18w Triple Biax 4-Pin	1/6lbs
	<b>CFH80C-218T-E</b> 8" Horizontal Mounting Frame	14-1/2" W x 13-1/2"L x 6"D Cutout: 7-7/8" Ø	120v/277v HPF Electronic	(2) 18w Triple Biax 4-Pin	1/6lbs
	<b>CFH80C-12632T-E</b> 8" Horizontal Mounting Frame	14-1/2" W x 13-1/2"L x 6"D Cutout: 7-7/8" Ø	120v/277v HPF Electronic	(1) 26w or 32w Triple Biax 4-Pin	1/6lbs
	<b>CFH80C-22632T-E</b> 8" Horizontal Mounting Frame	14-1/2" W x 13-1/2"L x 6"D Cutout: 7-7/8" Ø	120v/277v HPF Electronic	(2) 26w or 32w Triple Biax 4-Pin	1/6lbs
	<b>RSCHB</b> C-Channel Hanger Bars (A set of two) (T-Bar)	1-1/2" W x 25-1/8"L x 1/2"D			1/2lbs

## RECESSED LIGHTING – 8" ARCHITECTURAL INCANDESCENT TRIMS

	<b>MODEL DESCRIPTION</b>	<b>DIMENSION ADJUSTABILITY</b>	<b>FINISH</b>	<b>STD PKG PCS/WGT</b>
	<b>TM881</b> Open Reflector	7-1/4" A x 9-1/2"Ø	CHWH, GDWH CHST, GDST	6/6lbs



Finish Key:

CHST:	Specular Reflector, Satin Chrome Trim
CHWH:	Specular Reflector, White Trim
GDST:	Specular Gold, Satin Chrome Trim
GDWH:	Specular Gold, White Trim

## RECESSED LIGHTING – 8" ARCHITECTURAL INCANDESCENT HOUSINGS

**Features:**

- All fixtures have thermally protected housings.
- UL Listed for damp locations.
- UL Listed for feed through.
- Non IC units – keep housing 3" away from insulation.
- Adjustable socket.
- Lamps not included.
- Special universal mounting bracket accepts ½" EMT, C-Channel, T-Bar fasteners and bar hangers (not included), adjustable 5" above and below ceiling.

	<b>MODEL DESCRIPTION</b>	<b>DIMENSION CUTOUT</b>	<b>VOLT</b>	<b>MAX WATT</b>	<b>STD PKG PCS/WGT</b>
	<b>RS80B</b> 8" Architectural Incandescent Housing for New Construction	14-1/2" W x 13-1/2"L x 11-1/4"D Cutout: 7-7/8" Ø	120v	300w Par 38, PS25	1/5lbs
	<b>RSCHB</b> C-Channel Hanger Bars (A set of two) (T-Bar)	1-1/2" W x 25-1/8"L x 1/2"D			1/2lbs

## RECESSED LIGHTING – 8" ARCHITECTURAL METAL HALIDE TRIMS

	MODEL DESCRIPTION	DIMENSION ADJUSTABILITY	FINISH	STD PKG PCS/WGT
	<b>TM881</b> Open Reflector	7-1/4" A x 9-1/2"Ø	CHWH, GDWH CHST, GDST	6/6lbs





**Finish Key:**

CHST:	Specular Reflector, Satin Chrome Trim
CHWH:	Specular Reflector, White Trim
GDST:	Specular Gold, Satin Chrome Trim
GDWH:	Specular Gold, White Trim

## RECESSED LIGHTING – 8" ARCHITECTURAL METAL HALIDE HOUSINGS

**Features:**

- All fixtures have thermally protected housings.
- UL Listed for damp locations.
- UL Listed for feed through.
- Non IC units – keep housing 3" away from insulation.
- Adjustable socket.
- Lamps not included.
- Special universal mounting bracket accepts ½" EMT, C-Channel, T-Bar fasteners and bar hangers (not included), adjustable 5" above and below ceiling.
- Medium base porcelain socket.
- Extra large junction box with 7-1/2" and 1-3/4" pry out. Listed for branch wiring and up to eight 12 AWG 90°C Conductors.

	MODEL DESCRIPTION	DIMENSION CUTOUT	VOLT	MAX WATT LAMP TYPE	STD PKG PCS/WGT
<b>8" Architectural Metal Halide Universal Housing</b>					
	<b>MH80A-35-E1</b>	14-1/2" W x 13-1/2"L x 11-1/4"D Cutout: 7-7/8" Ø	120v Electronic	35w Par20, Par30L	1/8lbs
	<b>MH80A-35-E2</b>	14-1/2" W x 13-1/2"L x 11-1/4"D Cutout: 7-7/8" Ø	277v Electronic	35w Par20, Par30L	1/8lbs
	<b>MH80A-70-E1</b>	14-1/2" W x 13-1/2"L x 11-1/4"D Cutout: 7-7/8" Ø	120v Electronic	70w ED17 ED17, Par30L, Par38	1/8lbs
	<b>MH80A-70-E2</b>	14-1/2" W x 13-1/2"L x 11-1/4"D Cutout: 7-7/8" Ø	277v Electronic	70w ED17 ED17, Par30L, Par38	1/8lbs
	<b>MH80A-100-E1</b>	14-1/2" W x 13-1/2"L x 11-1/4"D Cutout: 7-7/8" Ø	120v Electronic	100w ED17, Par38	1/8lbs
	<b>MH80A-100-E2</b>	14-1/2" W x 13-1/2"L x 11-1/4"D Cutout: 7-7/8" Ø	277v Electronic	100w ED17, Par38	1/8lbs
	<b>MH80A-150-E1</b>	14-1/2" W x 13-1/2"L x 11-1/4"D Cutout: 7-7/8" Ø	120v Electronic	150w ED17, Par38	1/8lbs
	<b>MH80A-150-E2</b>	14-1/2" W x 13-1/2"L x 11-1/4"D Cutout: 7-7/8" Ø	277v Electronic	150w ED17, Par38	1/8lbs
	<b>RSCHB</b> C-Channel Hanger Bars (A set of two) (T-Bar)	1-1/2" W x 25-1/8"L x 1/2"D			1/2lbs

## RECESSED LIGHTING – 8" ARCHITECTURAL VERTICAL COMPACT FLUORESCENT TRIMS

	<b>MODEL DESCRIPTION</b>	<b>DIMENSION ADJUSTABILITY</b>	<b>FINISH</b>	<b>STD PKG PCS/WGT</b>
	<b>TM881</b> Open Reflector	7-1/4" A x 9-1/2"Ø	CHWH, GDWH CHST, GDST	6/6lbs





Finish Key:

CHST:	Specular Reflector, Satin Chrome Trim
CHWH:	Specular Reflector, White Trim
GDST:	Specular Gold, Satin Chrome Trim
GDWH:	Specular Gold, White Trim

## RECESSED LIGHTING – 8" ARCHITECTURAL VERTICAL COMPACT FLUORESCENT HOUSINGS

**Features:**

- All fixtures have thermally protected housings.
- UL Listed for damp locations.
- UL Listed for feed through.
- Non IC units – keep housing 3" away from insulation.
- Adjustable socket.
- Lamps not included.
- Special universal mounting bracket accepts ½" EMT, C-Channel, T-Bar fasteners and bar hangers (not included), adjustable 5" above and below ceiling.

	<b>MODEL DESCRIPTION</b>	<b>DIMENSION CUTOUT</b>	<b>VOLT</b>	<b>MAX WATT LAMP</b>	<b>STD PKG PCS/WGT</b>
	<b>CFV80A-113-E</b> 8" Vertical Mounting Frame	14-1/2" W x 13-1/2"L x 11-1/4"D Cutout: 7-7/8" Ø	120v/277v HPF Electronic	(1) 13w 4-Pin Quad or Triple Biax lamp	1/8lbs
	<b>CFV80A-118-E</b> 8" Vertical Mounting Frame	14-1/2" W x 13-1/2"L x 11-1/4"D Cutout: 7-7/8" Ø	120v/277v HPF Electronic	(1) 18w 4-Pin Quad or Triple Biax lamp	1/8lbs
	<b>CFV80A-12642-E</b> 8" Vertical Mounting Frame	14-1/2" W x 13-1/2"L x 11-1/4"D Cutout: 7-7/8" Ø	120v/277v HPF Electronic	(1) 26w Quad or Triple Biax or (1) 32w Triple Biax or (1) 42w Quad	1/8lbs
	<b>RSCHB</b> C-Channel Hanger Bars (A set of two) (T-Bar)	1-1/2" W x 25-1/8"L x 1/2"D			1/2lbs

## RECESSED LIGHTING – 8" ARCHITECTURAL HORIZONTAL COMPACT FLUORESCENT TRIMS











	<b>MODEL DESCRIPTION</b>	<b>DIMENSION ADJUSTABILITY</b>	<b>FINISH</b>	<b>STD PKG PCS/WGT</b>
	<b>TM891</b> Open Reflector	7-1/4" A x 9-1/2"Ø	CHWH, GDWH CHST, GDST	6/6lbs

Finish Key:  
 CHST: Specular Reflector, Satin Chrome Trim  
 CHWH: Specular Reflector, White Trim  
 GDST: Specular Gold, Satin Chrome Trim  
 GDWH: Specular Gold, White Trim









## RECESSED LIGHTING – 8" ARCHITECTURAL HORIZONTAL COMPACT FLUORESCENT HOUSINGS

### Features:

- All fixtures have thermally protected housings.
- UL Listed for damp locations.
- UL Listed for feed through.
- Non IC units – keep housing 3" away from insulation.
- Lamps not included.
- Special universal mounting bracket accepts ½" EMT, C-Channel, T-Bar fasteners and bar hangers (not included), adjustable 5" above and below ceiling.

	<b>MODEL DESCRIPTION</b>	<b>DIMENSION CUTOUT</b>	<b>VOLT</b>	<b>MAX WATT LAMP</b>	<b>STD PKG PCS/WGT</b>
	<b>CFH80A-109-M1</b> 8" Horizontal Mounting Frame	14-1/2" W x 13-1/2"L x 6"D Cutout: 7-7/8" Ø	120v HPF Magnetic	(1) 7w or 9w Twin 2-Pin	1/6lbs
	<b>CFH80A-109-M2</b> 8" Horizontal Mounting Frame	14-1/2" W x 13-1/2"L x 6"D Cutout: 7-7/8" Ø	277v HPF Magnetic	(1) 7w or 9w Twin 2-Pin	1/6lbs
	<b>CFH80A-209-M1</b> 8" Horizontal Mounting Frame	14-1/2" W x 13-1/2"L x 6"D Cutout: 7-7/8" Ø	120v HPF Magnetic	(2) 7w or 9w Twin 2-Pin	1/6lbs
	<b>CFH80A-209-M2</b> 8" Horizontal Mounting Frame	14-1/2" W x 13-1/2"L x 6"D Cutout: 7-7/8" Ø	277v HPF Magnetic	(2) 7w or 9w Twin 2-Pin	1/6lbs
	<b>CFH80A-113-E</b> 8" Horizontal Mounting Frame	14-1/2" W x 13-1/2"L x 6"D Cutout: 7-7/8" Ø	120v/277v HPF Electronic	(1) 13w Twin/Quad 4-Pin	1/6lbs
	<b>CFH80A-213-E</b> 8" Horizontal Mounting Frame	14-1/2" W x 13-1/2"L x 6"D Cutout: 7-7/8" Ø	120v/277v HPF Electronic	(2) 13w Twin/Quad 4-Pin	1/6lbs
	<b>CFH80A-118-E</b> 8" Horizontal Mounting Frame	14-1/2" W x 13-1/2"L x 6"D Cutout: 7-7/8" Ø	120v/277v HPF Electronic	(1) 18w Quad 4-Pin	1/6lbs
	<b>CFH80A-218-E</b> 8" Horizontal Mounting Frame	14-1/2" W x 13-1/2"L x 6"D Cutout: 7-7/8" Ø	120v/277v HPF Electronic	(2) 18w Quad 4-Pin	1/6lbs
	<b>CFH80A-126-E</b> 8" Horizontal Mounting Frame	14-1/2" W x 13-1/2"L x 6"D Cutout: 7-7/8" Ø	120v/277v HPF Electronic	(1) 26w Quad 4-Pin	1/6lbs
	<b>CFH80A-226-E</b> 8" Horizontal Mounting Frame	14-1/2" W x 13-1/2"L x 6"D Cutout: 7-7/8" Ø	120v/277v HPF Electronic	(2) 26w Quad 4-Pin	1/6lbs

RECESSED LIGHTING - 8" ARCHITECTURAL HORIZONTAL COMPACT FLUORESCENT HOUSINGS ...  
cont'd



	<b>MODEL DESCRIPTION</b>	<b>DIMENSION CUTOUT</b>	<b>VOLT</b>	<b>MAX WATT LAMP</b>	<b>STD PKG PCS/WGT</b>
	<b>CFH80A-113T-E</b> 8" Horizontal Mounting Frame	14-1/2" W x 13-1/2"L x 6"D Cutout: 7-7/8" Ø	120v/277v HPF Electronic	(1) 13w Triple Biax 4-Pin	1/6lbs
	<b>CFH80A-213T-E</b> 8" Horizontal Mounting Frame	14-1/2" W x 13-1/2"L x 6"D Cutout: 7-7/8" Ø	120v/277v HPF Electronic	(2) 13w Triple Biax 4-Pin	1/6lbs
	<b>CFH80A-118T-E</b> 8" Horizontal Mounting Frame	14-1/2" W x 13-1/2"L x 6"D Cutout: 7-7/8" Ø	120v/277v HPF Electronic	(1) 18w Triple Biax 4-Pin	1/6lbs
	<b>CFH80A-218T-E</b> 8" Horizontal Mounting Frame	14-1/2" W x 13-1/2"L x 6"D Cutout: 7-7/8" Ø	120v/277v HPF Electronic	(2) 18w Triple Biax 4-Pin	1/6lbs
	<b>CFH80A-12632T-E</b> 8" Horizontal Mounting Frame	14-1/2" W x 13-1/2"L x 6"D Cutout: 7-7/8" Ø	120v/277v HPF Electronic	(1) 26w or 32w Triple Biax 4-Pin	1/6lbs
	<b>CFH80A-22632T-E</b> 8" Horizontal Mounting Frame	14-1/2" W x 13-1/2"L x 6"D Cutout: 7-7/8" Ø	120v/277v HPF Electronic	(2) 26w or 32w Triple Biax 4-Pin	1/6lbs
	<b>CFH80A-132T-E</b> 8" Horizontal Mounting Frame	14-1/2" W x 13-1/2"L x 6"D Cutout: 7-7/8" Ø	120v/277v HPF Electronic	(1) 32w Triple Biax 4-Pin	1/6lbs
	<b>CFH80A-232T-E</b> 8" Horizontal Mounting Frame	14-1/2" W x 13-1/2"L x 6"D Cutout: 7-7/8" Ø	120v/277v HPF Electronic	(2) 32w Triple Biax 4-Pin	1/6lbs
	<b>RSCHB</b> C-Channel Hanger Bars (A set of two) (T-Bar)	1-1/2" W x 25-1/8"L x 1/2"D			1/2lbs

## RECESSED LIGHTING – QUICK START RECESSED HOUSINGS/TRIMS

The Quick Start one-step system is an economical and simple solution for any commercial and residential application.

### Features:







- One-piece housing assembly with a secured clip design for a simply fastening system.
- Compatible with regular or suspended ceilings – new construction or remodeling.
- All fixtures have thermally protected housings.
- All Housings are UL Listed for damp locations.
- Detachable junction boxes.
- For use with standard dimmers.
- Line Voltage fixtures are available for Par20, Par30 or MR16 GU10 light sources.
- Lamps not included.

	<b>MODEL DESCRIPTION</b>	<b>DIMENSION CUTOUT</b>	<b>VOLT</b>	<b>MAX WATT</b>	<b>FINISH</b>	<b>STD PKG PCS/WGT</b>
	<b>HRS14</b> 2-Piece Adjustable Trim & Housing Combination Lamp: MR16 GU10	Housing: 4-1/2"Ø x 5-3/8" D Cutout: 3-3/4"Ø 35° adjustability from vertical	120v	50w	WH CH, PB	10/15lbs
	<b>RS20</b> 2-Piece Adjustable Trim & Housing Combination Lamp: Par20	Housing: 5-1/4"Ø x 6-1/8" D Cutout: 4-1/2"Ø 35° adjustability from vertical	120v	50w	WH	10/15lbs
	<b>RS30</b> Step Baffled Trim & Housing Combination Lamp: Par30	Housing: 5-3/4"Ø x 7" D Cutout: 4-3/4"Ø	120v	50w	BKWH WHWH	10/16lbs

### Finish Key:

BKWH	Black Baffle, White Trim
CH	Chrome
PB	Polished Brass
WH	White
WHWH	White Baffle, White Trim

## RECESSED LIGHTING - LOW VOLTAGE MODULES







	MODEL DESCRIPTION	DIMENSION CUTOUT	VOLT	LAMP MAX WATT	FINISH	STD PKG PCS/WGT
	<b>2K/L101</b> 1-Light Linear With built-in transformer	4-3/4"L x 4-3/4"W x 5-5/8"D Cutout: 3-5/8"L x 3-5/8"W Pivot: 120°, Rotation: 358° Adjustability: 45° from vertical	12v	(1) MR16 50w	MS, WH	12/31lbs
	<b>2K/L102</b> 2-Light Linear With built-in transformer	8-1/2"L x 4-3/4"W x 5-5/8"D Cutout: 7-1/4"L x 3-5/8"W Pivot: 120°, Rotation: 358° Adjustability: 45° from vertical	12v	(2) MR16 50w	MS, WH	12/53lbs
	<b>2K/L103</b> 3-Light Linear With built-in transformer	12-1/4"L x 4-3/4"W x 5-5/8"D Cutout: 11"L x 3-5/8"W Pivot: 120°, Rotation: 358° Adjustability: 45° from vertical	12v	(3) MR16 50w	MS, WH	6/36lbs
	<b>2K/L104</b> 4-Light Linear With built-in transformer	15-7/8"L x 4-3/4"W x 5-5/8"D Cutout: 14-3/4"L x 3-5/8"W Pivot: 120°, Rotation: 358° Adjustability: 45° from vertical	12v	(4) MR16 50w	MS, WH	4/32lbs
	<b>2K/L106</b> 6-Light Linear With built-in transformer	22-5/8"L x 4-3/4"W x 5-5/8"D Cutout: 22-1/8"L x 3-5/8"W Pivot: 120°, Rotation: 358° Adjustability: 45° from vertical	12v	(6) MR16 50w	MS, WH	4/29lbs
	<b>2K/L202</b> 4-Light Square With built-in transformer	8-1/2"L x 8-1/2"W x 5-5/8"D Cutout: 7-3/8"L x 7-3/8"W Pivot: 120°, Rotation: 358° Adjustability: 45° from vertical	12v	(4) MR16 50w	MS, WH	4/33lbs
	<b>2K/L203</b> 6-Light Rectangular With built-in transformer	12-1/8"L x 8-1/2"W x 5-5/8"D Cutout: 10-7/8"L x 7-3/8"W Pivot: 120°, Rotation: 358° Adjustability: 45° from vertical	12v	(6) MR16 50w	MS, WH	4/36lbs

Please consult factory for New Construction units with Hanger Bars.

### Finish Key:

MS Metallic Silver Trim, Black interior  
WH White Trim, Black interior

## RECESSED LIGHTING - LINE VOLTAGE MODULES

	MODEL DESCRIPTION	DIMENSION CUTOUT	VOLT	LAMP MAX WATT	FINISH	STD PKG PCS/WGT
	<b>2K/H101</b> 1-Light Linear	4-3/4"L x 4-3/4"W x 5-5/8"D Cutout: 3-5/8"L x 3-5/8"W Pivot: 120°, Rotation: 358° Adjustability: 45° from vertical	120v	(1) MR16 GU10 50w	MS, WH	12/29lbs
	<b>2K/H102</b> 2-Light Linear	8-1/2"L x 4-3/4"W x 5-5/8"D Cutout: 7-1/4"L x 3-5/8"W Pivot: 120°, Rotation: 358° Adjustability: 45° from vertical	120v	(2) MR16 GU10 50w	MS, WH	12/49lbs
	<b>2K/H103</b> 3-Light Linear	12-1/4"L x 4-3/4"W x 5-5/8"D Cutout: 11"L x 3-5/8"W Pivot: 120°, Rotation: 358° Adjustability: 45° from vertical	120v	(3) MR16 GU10 50w	MS, WH	6/33lbs
	<b>2K/H104</b> 4-Light Linear	15-7/8"L x 4-3/4"W x 5-5/8"D Cutout: 14-3/4"L x 3-5/8"W Pivot: 120°, Rotation: 358° Adjustability: 45° from vertical	120v	(4) MR16 GU10 50w	MS, WH	4/28lbs
	<b>2K/H106</b> 6-Light Linear	22-5/8"L x 4-3/4"W x 5-5/8"D Cutout: 22-1/8"L x 3-5/8"W Pivot: 120°, Rotation: 358° Adjustability: 45° from vertical	120v	(6) MR16 GU10 50w	MS, WH	4/26lbs
	<b>2K/H202</b> 4-Light Square	8-1/2"L x 8-1/2"W x 5-5/8"D Cutout: 7-3/8"L x 7-3/8"W Pivot: 120°, Rotation: 358° Adjustability: 45° from vertical	120v	(4) MR16 GU10 50w	MS, WH	4/26lbs
	<b>2K/H203</b> 6-Light Rectangular	12-1/8"L x 8-1/2"W x 5-5/8"D Cutout: 10-7/8"L x 7-3/8"W Pivot: 120°, Rotation: 358° Adjustability: 45° from vertical	120v	(6) MR16 GU10 50w	MS, WH	4/29lbs







Please consult factory for New Construction units with Hanger Bars.

**Finish Key:**

MS Metallic Silver Trim, Black interior  
WH White Trim, Black interior

## DISPLAY LIGHTING – SLEEK PLUS T4 FLUORESCENT LIGHTING SYSTEM

Sleek Plus T4 Fluorescent fixtures are furnished with replaceable lamps, tight-fit direct connectors, metal mounting clips and ribbed lamp covers. The housing is made of extruded aluminum, with white enamel painted finish. The fixture features a built-in instant start, no flickering, silent Electronic Ballast rated AC120v 50-60Hz. The ribbed acrylic diffuser lamp cover fits securely on the housing of the fixture with no light leaks, warping or deformed lens. The T4 lamps (included with fixtures) are energy efficient, long life with a 20,000 hours rating. Additional power supply cables, connecting cables, hardwire boxes, and replacement lamps sold separately. Sleek Plus are linkable up to 10 units for 6w through 20w fixtures; or up to 5 units for 21w through 28w fixtures, not to exceed 200w to a power cord. Compatible with 2-WIRE COMPONENTS on page 36.

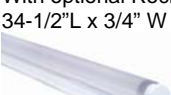
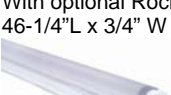
DESCRIPTION DIMENSION (2-Wire Sleek Plus shown below)	LAMP OPTIONS	MAX WATT	LUMENS*	2-WIRE T4 SLEEK PLUS MODEL	3-WIRE GROUNDED T4 SLEEK PLUS MODEL	STD PKG PCS/WGT
6w Fixture Not offered with Rocker Switch*** 9-3/8"L x 3/4" W x 1-1/4"H 	3000K	6w	480	SP-6/30	SG-6/30	24/10lbs
	4100K	6w	480	SP-6/41	SG-6/41	
	6400K	6w	480	SP-6/64	SG-6/64	
	Red	6w	480	SP-6/RD	SG-6/RD	
	Blue	6w	480	SP-6/BU	SG-6/BU	
	Green	6w	480	SP-6/GN	SG-6/GN	
	Black	6w	480	SP-6/BK	SG-6/BK	
8w Fixture With optional Rocker Switch** 13-1/2"L x 3/4" W x 1-1/4"H 	3000K	8w	600	SP-8/30	SG-8/30	24/13lbs
	4100K	8w	600	SP-8/41	SG-8/41	
	6400K	8w	600	SP-8/64	SG-8/64	
	Red	8w	600	SP-8/RD	SG-8/RD	
	Blue	8w	600	SP-8/BU	SG-8/BU	
	Green	8w	600	SP-8/GN	SG-8/GN	
	Black	8w	600	SP-8/BK	SG-8/BK	
12w Fixture With optional Rocker Switch** 17-1/2"L x 3/4" W x 1-1/4"H 	3000K	12w	800	SP-12/30	SG-12/30	24/15lbs
	4100K	12w	800	SP-12/41	SG-12/41	
	6400K	12w	800	SP-12/64	SG-12/64	
	Red	12w	800	SP-12/RD	SG-12/RD	
	Blue	12w	800	SP-12/BU	SG-12/BU	
	Green	12w	800	SP-12/GN	SG-12/GN	
	Black	12w	800	SP-12/BK	SG-12/BK	
16w Fixture With optional Rocker Switch** 19-1/2"L x 3/4" W x 1-1/4"H 	3000K	16w	1000	SP-16/30	SG-16/30	24/17lbs
	4100K	16w	1000	SP-16/41	SG-16/41	
	6400K	16w	1000	SP-16/64	SG-16/64	
	Red	16w	1000	SP-16/RD	SG-16/RD	
	Blue	16w	1000	SP-16/BU	SG-16/BU	
	Green	16w	1000	SP-16/GN	SG-16/GN	
	Black	16w	1000	SP-16/BK	SG-16/BK	
20w Fixture With optional Rocker Switch** 21"L x 3/4" W x 1-1/4"H 	3000K	20w	1350	SP-20/30	SG-20/30	24/18lbs
	4100K	20w	1350	SP-20/41	SG-20/41	
	6400K	20w	1350	SP-20/64	SG-20/64	
	Red	20w	1350	SP-20/RD	SG-20/RD	
	Blue	20w	1350	SP-20/BU	SG-20/BU	
	Green	20w	1350	SP-20/GN	SG-20/GN	
	Black	20w	1350	SP-20/BK	SG-20/BK	
22w Fixture With optional Rocker Switch** 29"L x 3/4" W x 1-1/4"H 	4100K	22w	1850	N/A	SG-22/41	24/29lbs
24w Fixture With optional Rocker Switch** 34-1/2"L x 3/4" W x 1-1/4"H 	3000K	24w	2150	SP-24/30	SG-24/30	24/29lbs
	4100K	24w	2150	SP-24/41	SG-24/41	
	6400K	24w	2150	SP-24/64	SG-24/64	
	Red	24w	2150	SP-24/RD	SG-24/RD	
	Blue	24w	2150	SP-24/BU	SG-24/BU	
	Green	24w	2150	SP-24/GN	SG-24/GN	
	Black	24w	2150	SP-24/BK	SG-24/BK	
28w Fixture With optional Rocker Switch** 46-1/4"L x 3/4" W x 1-1/4"H 	3000K	28w	2900	SP-28/30	SG-28/30	24/32lbs
	4100K	28w	2900	SP-28/41	SG-28/41	
	6400K	28w	2900	SP-28/64	SG-28/64	
	Red	28w	2900	SP-28/RD	SG-28/RD	
	Blue	28w	2900	SP-28/BU	SG-28/BU	
	Green	28w	2900	SP-28/GN	SG-28/GN	
	Black	28w	2900	SP-28/BK	SG-28/BK	

\*The information on LUMENS is based on cool white lamps.

\*\*To order fixtures with Rocker Switches, add suffix SW. For example, the 8w 2-wire fixture 3000K lamp with a Rocker Switch will be SP-8SW/30. Price is additional.







\*\*\*The 6w fixture is not available with a Rocker Switch. With the 2-wire T4 fixture, a cord and plug with switch (SP-PCSW) may be ordered separately – See page 36.

### Color Temperature:

3000K: Warm White (Soft White)  
4100K: Cool White  
6400K: Daylight

## DISPLAY LIGHTING – SLEEK PLUS T5 FLUORESCENT LIGHTING SYSTEM

Sleek Plus T5 Fluorescent fixtures are furnished with replaceable lamps, tight-fit direct connectors, metal mounting clips and ribbed lamp covers. The housing is made of extruded aluminum, with white enamel painted finish. The fixture features a built-in instant start, no flickering, silent Electronic Ballast rated AC120v 50-60Hz. The ribbed acrylic diffuser lamp cover fits securely on the housing of the fixture with no light leaks, warping or deformed lens. The T5 lamps (included with fixtures) are energy efficient, long life with a 20,000 hours rating. Additional power supply cables, connecting cables, hardwire boxes, and replacement lamps sold separately. Sleek Plus T5 are linkable up to 10 units for 6w through 14w fixtures; or up to 5 units for 21w through 35w fixtures, not to exceed 200w to a power cord. Compatible with 2-WIRE COMPONENTS on page 36.

DESCRIPTION DIMENSION (3-Wire Grounded Sleek Plus shown)	LAMP OPTIONS	MAX WATT	LUMENS*	2-WIRE T5 SLEEK PLUS MODEL	3-WIRE GROUNDED T5 SLEEK PLUS MODEL	STD PKG PCS/WGT
6w Fixture without rocker switch Not offered with Rocker Switch 9-3/8"L x 3/4" W x 1-1/2"H 	3000K	6w	480	N/A	SG5-6/30	24/11lbs
	3500K	6w	480	N/A	SG5-6/35	
	4100K	6w	480	N/A	SG5-6/41	
	5000K	6w	480	N/A	SG5-6/50	
	6400K	6w	480	N/A	SG5-6/64	
8w Fixture With optional Rocker Switch** 12-3/8"L x 3/4" W x 1-1/2"H 	3000K	8w	600	N/A	SG5-8/30	24/13lbs
	3500K	8w	600	N/A	SG5-8/35	
	4100K	8w	600	N/A	SG5-8/41	
	5000K	8w	600	N/A	SG5-8/50	
	6400K	8w	600	N/A	SG5-8/64	
14w Fixture With optional Rocker Switch** 22-3/4"L x 3/4" W x 1-1/2"H 	3000K	14w	1350	SP5-14/30	SG5-14/30	24/21lbs
	3500K	14w	1350	SP5-14/35	SG5-14/35	
	4100K	14w	1350	SP5-14/41	SG5-14/41	
	5000K	14w	1350	SP5-14/50	SG5-14/50	
	6400K	14w	1350	SP5-14/64	SG5-14/64	
21w Fixture With optional Rocker Switch** 34-1/2"L x 3/4" W x 1-1/2"H 	3000K	21w	2150	SP5-21/30	SG5-21/30	24/28lbs
	3500K	21w	2150	SP5-21/35	SG5-21/35	
	4100K	21w	2150	SP5-21/41	SG5-21/41	
	5000K	21w	2150	SP5-21/50	SG5-21/50	
	6400K	21w	2150	SP5-21/64	SG5-21/64	
28w Fixture With optional Rocker Switch** 46-1/4"L x 3/4" W x 1-1/2"H 	3000K	28w	2900	SP5-28/30	SG5-28/30	24/36lbs
	3500K	28w	2900	SP5-28/35	SG5-28/35	
	4100K	28w	2900	SP5-28/41	SG5-28/41	
	5000K	28w	2900	SP5-28/50	SG5-28/50	
	6400K	28w	2900	SP5-28/64	SG5-28/64	
35w Fixture With optional Rocker Switch** 58"L x 3/4" W x 1-1/2"H 	3000K	35w	3650	N/A	SG5-35/30	24/44lbs
	3500K	35w	3650	N/A	SG5-35/35	
	4100K	35w	3650	N/A	SG5-35/41	
	5000K	35w	3650	N/A	SG5-35/50	
	6400K	35w	3650	N/A	SG5-35/64	

\*The information on LUMENS is based on cool white lamps.







\*\*To order fixtures with Rocker Switches, add suffix SW. For example, the 8w 2-wire fixture 3000K lamp with a Rocker Switch will be SP5-8/30SW. Price is additional.

### Color Temperature:

3000K:	Warm White (Soft White)
3500K:	Natural White
4100K:	Cool White
5000K:	Designer White
6400K:	Daylight

## DISPLAY LIGHTING – SLEEK PLUS T5 CORNER LIGHT FLUORESCENT LIGHTING SYSTEM

Sleek Plus T5 Corner Light Fluorescent fixtures are furnished with replaceable lamps, tight-fit direct connectors, metal mounting clips and ribbed lamp covers. The housing is made of extruded aluminum, with white enamel painted finish. The fixture features a built-in instant start, no flickering, silent Electronic Ballast rated AC120v 50-60Hz. The ribbed acrylic lamp cover fits securely on the housing of the fixture with no light leaks, warping or deformed lens. The fixture includes a removable specular aluminum reflector strip for precise directed lighting. The T5 lamps (included with fixtures) are energy efficient, long life with a 20,000 hours rating. Additional power supply cables, connecting cables, hardwire boxes, and replacement lamps sold separately. Sleek Plus T5 Corner Lights are linkable up to 10 units for 6w through 14w fixtures; or up to 5 units for 21w through 35w fixtures, not to exceed 200w to a power cord. Compatible with 3-WIRE GROUNDED COMPONENTS on page 36.











DESCRIPTION DIMENSION	LAMP OPTIONS	MAX WATT	LUMENS*	3-WIRE GROUNDED T5 SLEEK PLUS MODEL	STD PKG PCS/WGT
6w Fixture With Rocker Switch 10-3/4"L x 2" W x 1-5/8"H 	3000K	6w	480	SG5CL-6/30	24/16lbs
	3500K	6w	480	SG5CL-6/35	
	4100K	6w	480	SG5CL-6/41	
	5000K	6w	480	SG5CL-6/50	
	6400K	6w	480	SG5CL-6/64	
8w Fixture With Rocker Switch 13-3/4"L x 2" W x 1-5/8"H 	3000K	8w	600	SG5CL-8/30	24/19lbs
	3500K	8w	600	SG5CL-8/35	
	4100K	8w	600	SG5CL-8/41	
	5000K	8w	600	SG5CL-8/50	
	6400K	8w	600	SG5CL-8/64	
14w Fixture With Rocker Switch 24"L x 2" W x 1-5/8"H 	3000K	14w	1350	SG5CL-14/30	24/26lbs
	3500K	14w	1350	SG5CL-14/35	
	4100K	14w	1350	SG5CL-14/41	
	5000K	14w	1350	SG5CL-14/50	
	6400K	14w	1350	SG5CL-14/64	
21w Fixture With Rocker Switch 35-3/4"L x 2" W x 1-5/8"H 	3000K	21w	2150	SG5CL-21/30	24/44lbs
	3500K	21w	2150	SG5CL-21/35	
	4100K	21w	2150	SG5CL-21/41	
	5000K	21w	2150	SG5CL-21/50	
	6400K	21w	2150	SG5CL-21/64	
28w Fixture With Rocker Switch 47-5/8"L x 2" W x 1-5/8"H 	3000K	28w	2900	SG5CL-28/30	24/57lbs
	3500K	28w	2900	SG5CL-28/35	
	4100K	28w	2900	SG5CL-28/41	
	5000K	28w	2900	SG5CL-28/50	
	6400K	28w	2900	SG5CL-28/64	
35w Fixture With Rocker Switch 59-3/8"L x 2" W x 1-5/8"H 	3000K	35w	3650	SG5CL-35/30	24/67lbs
	3500K	35w	3650	SG5CL-35/35	
	4100K	35w	3650	SG5CL-35/41	
	5000K	35w	3650	SG5CL-35/50	
	6400K	35w	3650	SG5CL-35/64	

\*The information on LUMENS is based on cool white lamps.

### Color Temperature:

3000K: Warm White (Soft White)  
 3500K: Natural White  
 4100K: Cool White  
 5000K: Designer White  
 6400K: Daylight

DISPLAY LIGHTING - SLEEK PLUS T4 & T5 FLUORESCENT LIGHTING SYSTEM - COMPONENTS

	<b>DESCRIPTION</b>	<b>2-WIRE T4 &amp; T5 SLEEK PLUS MODEL</b>	<b>3-WIRE GROUNDED T4 &amp; T5 SLEEK PLUS T5 CORNER LIGHT MODEL</b>	<b>STD PKG PCS/WGT</b>
	Direct Connector	<b>SP-DC</b>	<b>SG-DC</b>	24/2lbs
	6" Connecting Cable 12" Connecting Cable 24" Connecting Cable 36" Connecting Cable	<b>SP-CC6</b> <b>SP-CC12</b> <b>SP-CC24</b> <b>SP-CC36</b>	<b>SG-CC6</b> <b>SG-CC12</b> <b>SG-CC24</b> <b>SG-CC36</b>	24/2lbs
	6" Connecting Cable – Right Angle 12" Connecting Cable – Right Angle 24" Connecting Cable – Right Angle 36" Connecting Cable – Right Angle	<b>SP-CC6L</b> <b>SP-CC12L</b> <b>SP-CC24L</b> <b>SP-CC36L</b>	<b>SG-CC6L</b> <b>SG-CC12L</b> <b>SG-CC24L</b> <b>SG-CC36L</b>	24/2lbs
	6' Power Cord & Plug	<b>SP-PC</b> 2-prong plug	<b>SG-PC</b> 3-Prong Plug	24/9lbs
	6' Power Cord & Plug with Switch	<b>SP-PCSW</b> 2-prong plug	<b>N/A</b>	24/9lbs
	6' Right Angle Power Cord & Plug	<b>SP-PCL</b> 2-prong plug	<b>SG-PCL</b> 3-Prong Plug	24/9lbs
	6' Grounded Power Cord & 3-prong Plug	<b>SP-PC3</b>	<b>N/A</b>	24/9lbs
	Plastic Hardwire box with Control Switch 3-5/8"L x 2-1/4"W x 1-3/8"H	<b>SP-B</b>	<b>SG-B</b>	24/4lbs
	Commercial Grade Metal Hardwire Box – enables fixtures to be controlled by wall switch 2-3/4"L x 1-3/4"W x 1-3/4"H	<b>SP-BM</b>	<b>SG-BM</b>	24/8lbs
	Sleek Plus Power Strip with 6 outlets Includes (1) Direct Connector (SP-DC) 36"L x 7/8"W x 7/8"H	<b>SP-PS3</b>	<b>SG-PS3</b>	6/7lbs
	Sleek Plus Power Strip with 12 outlets Includes (1) Direct Connector (SP-DC) 72"L x 7/8"W x 7/8"H	<b>SP-PS6</b>	<b>SG-PS6</b>	6/14lbs

## DISPLAY LIGHTING - SLEEK MODULES T5 FLUORESCENT LIGHTING SYSTEM

1-Light and 2-light T5 Linkable Fluorescent Reflector Modules are furnished complete with streamlined specular reflector chrome housing, tight-fit direct connectors, ribbed lamp covers, and replaceable lamps. The housing is made of extruded aluminum. The fixture features a built-in instant start, no flickering, silent Electronic Ballast rated AC120v 50-60Hz. The ribbed acrylic diffuser lamp cover fits securely on the housing of the fixture with no light leaks, warping or deformed lens. The T5 lamps (included with fixtures) are energy efficient, long life with a 20,000 hours rating. Sleek Modules are linkable with Direct Connectors or Connecting Cables, not to exceed 200w to a power cord.





DESCRIPTION DIMENSION	LAMP OPTIONS	MAX WATT	3-WIRE GROUNDED T5 SINGLE LIGHT MODULES		3-WIRE GROUNDED T5 DOUBLE LIGHT MODULES		STD PKG PCS/WGT
			MODEL	LUMENS	MODEL	LUMENS	
6w Fixture	3000	6w	<b>SM-6S/30</b>	480	<b>N/A</b>		12/8lbs
Single	4100	6w	<b>SM-6S/41</b>	480	<b>N/A</b>		
10-3/8"L x 2" W x 7/8"H	6400	6w	<b>SM-6S/64</b>	480	<b>N/A</b>		
14w Fixture	3000	14w	<b>SM-14S/30</b>	1350	<b>SM-14D/30</b>	2700	Single
Single	4100	14w	<b>SM-14S/41</b>	1350	<b>SM-14D/41</b>	2700	12/15lbs
23-1/2"L x 2" W x 7/8"H	6400	14w	<b>SM-14S/64</b>	1350	<b>SM-14D/64</b>	2700	Double 12/23lbs
Double 23-1/2"L x 3" W x 7/8"H							
21w Fixture	3000	21w	<b>SM-21S/30</b>	2150	<b>SM-21D/30</b>	4300	Single
Single	4100	21w	<b>SM-21S/41</b>	2150	<b>SM-21D/41</b>	4300	12/21lbs
35-1/2"L x 2" W x 7/8"H	6400	21w	<b>SM-21S/64</b>	2150	<b>SM-21D/64</b>	4300	
Double	Red*	21w	<b>SM-21S/RD</b>	2150	<b>SM-21D/RD</b>	4300	Double
35-1/2"L x 3" W x 7/8"H	Blue*	21w	<b>SM-21S/BU</b>	2150	<b>SM-21D/BU</b>	4300	12/33lbs
Double	Green*	21w	<b>SM-21S/GN</b>	2150	<b>SM-21D/GN</b>	4300	
35-1/2"L x 3" W x 7/8"H	Black*	21w	<b>SM-21S/BK</b>	2150	<b>SM-21D/BK</b>	4300	
28w Fixture	3000	28w	<b>SM-28S/30</b>	2900	<b>SM-28D/30</b>	5800	Single
Single	4100	28w	<b>SM-28S/41</b>	2900	<b>SM-28D/41</b>	5800	12/27lbs
47-1/2"L x 2" W x 7/8"H	6400	28w	<b>SM-28S/64</b>	2900	<b>SM-28D/64</b>	5800	
Double	Red*	28w	<b>SM-28S/RD</b>	2900	<b>SM-28D/RD</b>	5800	Double
47-1/2"L x 3" W x 7/8"H	Blue*	28w	<b>SM-28S/BU</b>	2900	<b>SM-28D/BU</b>	5800	12/40lbs
Double	Green*	28w	<b>SM-28S/GN</b>	2900	<b>SM-28D/GN</b>	5800	
47-1/2"L x 3" W x 7/8"H	Black*	28w	<b>SM-28S/BK</b>	2900	<b>SM-28D/BK</b>	5800	

\*Colored Lamps: The 21w and 28w fixtures with colored lamps are supplied with T4 colored lamps.

### Color Temperature:

3000K: Warm White (Soft White)  
4100K: Cool White  
6400K: Daylight









## DISPLAY LIGHTING - SLEEK MODULES T5 FLUORESCENT LIGHTING SYSTEM - COMPONENTS

	DESCRIPTION DIMENSION	MODEL	STD PKG WGT
	Direct Connector	<b>SM-DC</b>	24/2lbs
	6' Grounded Power Cable	<b>SM-PC</b>	24/8lbs
	6" Connecting Cable 12" Connecting Cable 24" Connecting Cable	<b>SM-CC6</b> <b>SM-CC12</b> <b>SM-CC24</b>	24/2lbs
	Hardwire box with control switch 4"L x 2 1/2" W x 1 1/2"H	<b>SM-B</b>	24/7lbs
	Swivel Assembly May be factory installed Requires 2 per fixture Extends fixture 1 3/4" at 90° angle	<b>SMV</b>	12/1lbs

# DISPLAY LIGHTING – REPLACEMENT T4 FLUORESCENT LAMPS

Average Life: 20,000 Hours

Burning Position: Any

	MODEL	VOLT	WATT	COLOR TEMP	LUMENS	CRI	MOL	STD PKG PCS/WGT
	SL4-L6/30	120v	6w	3000K	480	82+	1/2"Ø x 9"	100/10lbs
	SL4-L6/41	120v	6w	4100K	480	82+	1/2"Ø x 9"	
	SL4-L6/64	120v	6w	6400K	480	82+	1/2"Ø x 9"	
	SL4-L6/RD	120v	6w	Red	480	82+	1/2"Ø x 9"	
	SL4-L6/BU	120v	6w	Blue	480	82+	1/2"Ø x 9"	
	SL4-L6/GN	120v	6w	Green	480	82+	1/2"Ø x 9"	
	SL4-L6/BK	120v	6w	Black	480	82+	1/2"Ø x 9"	
	SL4-L8/30	120v	8w	3000K	600	82+	1/2"Ø x 13-1/8"	100/13lbs
	SL4-L8/41	120v	8w	4100K	600	82+	1/2"Ø x 13-1/8"	
	SL4-L8/64	120v	8w	6400K	600	82+	1/2"Ø x 13-1/8"	
	SL4-L8/RD	120v	8w	Red	600	82+	1/2"Ø x 13-1/8"	
	SL4-L8/BU	120v	8w	Blue	600	82+	1/2"Ø x 13-1/8"	
	SL4-L8/GN	120v	8w	Green	600	82+	1/2"Ø x 13-1/8"	
	SL4-L8/BK	120v	8w	Black	600	82+	1/2"Ø x 13-1/8"	
	SL4-L12/30	120v	12w	3000K	800	82+	1/2"Ø x 17"	100/16lbs
	SL4-L12/41	120v	12w	4100K	800	82+	1/2"Ø x 17"	
	SL4-L12/64	120v	12w	6400K	800	82+	1/2"Ø x 17"	
	SL4-L12/RD	120v	12w	Red	800	82+	1/2"Ø x 17"	
	SL4-L12/BU	120v	12w	Blue	800	82+	1/2"Ø x 17"	
	SL4-L12/GN	120v	12w	Green	800	82+	1/2"Ø x 17"	
	SL4-L12/BK	120v	12w	Black	800	82+	1/2"Ø x 17"	
	SL4-L16/30	120v	16w	3000K	1000	82+	1/2"Ø x 18-3/4"	100/17lbs
	SL4-L16/41	120v	16w	4100K	1000	82+	1/2"Ø x 18-3/4"	
	SL4-L16/64	120v	16w	6400K	1000	82+	1/2"Ø x 18-3/4"	
	SL4-L16/RD	120v	16w	Red	1000	82+	1/2"Ø x 18-3/4"	
	SL4-L16/BU	120v	16w	Blue	1000	82+	1/2"Ø x 18-3/4"	
	SL4-L16/GN	120v	16w	Green	1000	82+	1/2"Ø x 18-3/4"	
	SL4-L16/BK	120v	16w	Black	1000	82+	1/2"Ø x 18-3/4"	
	SL4-L20/30	120v	20w	3000K	1350	82+	1/2"Ø x 20-1/2"	100/18lbs
	SL4-L20/41	120v	20w	4100K	1350	82+	1/2"Ø x 20-1/2"	
	SL4-L20/64	120v	20w	6400K	1350	82+	1/2"Ø x 20-1/2"	
	SL4-L20/RD	120v	20w	Red	1350	82+	1/2"Ø x 20-1/2"	
	SL4-L20/BU	120v	20w	Blue	1350	82+	1/2"Ø x 20-1/2"	
	SL4-L20/GN	120v	20w	Green	1350	82+	1/2"Ø x 20-1/2"	
	SL4-L20/BK	120v	20w	Black	1350	82+	1/2"Ø x 20-1/2"	
	SL4-L22/41	120v	22w	4100K	1850	82+	1/2"Ø x 28"	100/25lbs
	SL4-L24/30	120v	24w	3000K	2150	82+	1/2"Ø x 34"	100/29lbs
	SL4-L24/41	120v	24w	4100K	2150	82+	1/2"Ø x 34"	
	SL4-L24/64	120v	24w	6400K	2150	82+	1/2"Ø x 34"	
	SL4-L24/RD	120v	24w	Red	2150	82+	1/2"Ø x 34"	
	SL4-L24/BU	120v	24w	Blue	2150	82+	1/2"Ø x 34"	
	SL4-L24/GN	120v	24w	Green	2150	82+	1/2"Ø x 34"	
	SL4-L24/BK	120v	24w	Black	2150	82+	1/2"Ø x 34"	
	SL4-L28/30	120v	28w	3000K	2900	82+	1/2"Ø x 45-3/4"	100/40lbs
	SL4-L28/41	120v	28w	4100K	2900	82+	1/2"Ø x 45-3/4"	
	SL4-L28/64	120v	28w	6400K	2900	82+	1/2"Ø x 45-3/4"	
	SL4-L28/RD	120v	28w	Red	2900	82+	1/2"Ø x 45-3/4"	
	SL4-L28/BU	120v	28w	Blue	2900	82+	1/2"Ø x 45-3/4"	
	SL4-L28/GN	120v	28w	Green	2900	82+	1/2"Ø x 45-3/4"	
	SL4-L28/BK	120v	28w	Black	2900	82+	1/2"Ø x 45-3/4"	







**Color Temperature:**

- 3000K Warm White (Soft White)
- 4100K Cool White
- 6400K Daylight

## DISPLAY LIGHTING – REPLACEMENT T5 FLUORESCENT LAMPS

Average Life: 20,000 Hours

Burning Position: Any

	MODEL	VOLT	WATT	COLOR TEMP	LUMENS	CRI	MOL	STD PKG PCS/WGT
	SL5-L6/30	120v	6w	3000K	480	82+	5/8"Ø x 9"	100/10lbs
	SL5-L6/35	120v	6w	3500K	480	82+	5/8"Ø x 9"	
	SL5-L6/41	120v	6w	4100K	480	82+	5/8"Ø x 9"	
	SL5-L6/50	120v	6w	5000K	480	82+	5/8"Ø x 9"	
	SL5-L6/64	120v	6w	6400K	480	82+	5/8"Ø x 9"	
	SL5-L8/30	120v	8w	3000K	600	82+	5/8"Ø x 12"	100/13lbs
	SL5-L8/35	120v	8w	3500K	600	82+	5/8"Ø x 12"	
	SL5-L8/41	120v	8w	4100K	600	82+	5/8"Ø x 12"	
	SL5-L8/50	120v	8w	5000K	600	82+	5/8"Ø x 12"	
	SL5-L8/64	120v	8w	6400K	600	82+	5/8"Ø x 12"	
	SL5-L14/30	120v	14w	3000K	1350	82+	5/8"Ø x 24"	100/20lbs
	SL5-L14/35	120v	14w	3500K	1350	82+	5/8"Ø x 24"	
	SL5-L14/41	120v	14w	4100K	1350	82+	5/8"Ø x 24"	
	SL5-L14/50	120v	14w	5000K	1350	82+	5/8"Ø x 24"	
	SL5-L14/64	120v	14w	6400K	1350	82+	5/8"Ø x 24"	
	SL5-L21/30	120v	21w	3000K	2150	82+	5/8"Ø x 36"	100/30lbs
	SL5-L21/35	120v	21w	3500K	2150	82+	5/8"Ø x 36"	
	SL5-L21/41	120v	21w	4100K	2150	82+	5/8"Ø x 36"	
	SL5-L21/50	120v	21w	5000K	2150	82+	5/8"Ø x 36"	
	SL5-L21/64	120v	21w	6400K	2150	82+	5/8"Ø x 36"	
	SL5-L28/30	120v	28w	3000K	2900	82+	5/8"Ø x 48"	100/40lbs
	SL5-L28/35	120v	28w	3500K	2900	82+	5/8"Ø x 48"	
	SL5-L28/41	120v	28w	4100K	2900	82+	5/8"Ø x 48"	
	SL5-L28/50	120v	28w	5000K	2900	82+	5/8"Ø x 48"	
	SL5-L28/64	120v	28w	6400K	2900	82+	5/8"Ø x 48"	
	SL5-L35/30	120v	35w	3000K	3650	82+	5/8"Ø x 60"	100/50lbs
	SL5-L35/35	120v	35w	3500K	3650	82+	5/8"Ø x 60"	
	SL5-L35/41	120v	35w	4100K	3650	82+	5/8"Ø x 60"	
	SL5-L35/50	120v	35w	5000K	3650	82+	5/8"Ø x 60"	
	SL5-L35/64	120v	35w	6400K	3650	82+	5/8"Ø x 60"	

### Color Temperature:

3000K:	Warm White (Soft White)
3500K:	Natural White
4100K:	Cool White
5000K:	Designer White
6400K:	Daylight

## DISPLAY LIGHTING – COLD CATHODE FLUORESCENT (CCF)

CCF fixtures offer high brightness, durability, long life, and a super slim profile. These fixtures are low voltage, and are extremely energy efficient, producing more lumens per watt than compact fluorescent lamps. Unlike halogen, CCFs do not cause color to fade, therefore making them ideal for garment display realizing its true color. With a very low heat output, CCFs are perfect for cosmetics display cases in retail. Applications include Under-shelf Lighting, Showcase Lighting, Backlight Bullnose, Kickplate Lighting, Cove and Valance Lighting, Backlight Graphics, Edgelight Glass or Acrylic Shelf, Edgelight Ultra Thin Light Boxes, Countertop and Shelf Displays.

### HOW TO ORDER:

- STEP 1. Specify the Number of Lamps, Length and Color Temperature**  
**STEP 2. Specify the Lamp/Reflector Configuration, and Reflector Type**  
**STEP 3. Match up the total wattage to the appropriate Power Supply**

### STEP 1. SPECIFY THE NUMBER OF LAMPS, LENGTH AND COLOR TEMPERATURE

#### Lamp Specifications:

- Diameter: 2.6mm ~ 3.0mm (Nominal)
- Lamp Life: 50,000 hours (more than 10 years of normal operation)
- Lamp Brightness: 36,000 – 39,000 cd/m<sup>2</sup>
- CRI: >85
- Phosphor: Rare Earth Phosphor
- Warm-up time: < 3 minutes
- Lamp Leads: High Temperature Silicon Wire – Solder Connection
- Lamp Wire Lead Lengths – Hot 6" L, Common Lamp Length – 6"+
- Lamp Wire Connections: Quick Connect Plug (Male)
- Operating temperature: 0°~70°
- Glass: Barosilicate

#### Inverter Specifications:

- Input Voltage: 12v DC
- Output Voltage: 550v – 1800v DC (Lamp dependant)
- Output Frequency: 40KHz
- Input Wire Leads: 6" L with Male DC Jack
- Output Wire Leads: High Temperature Silicon Wire 4" L with Quick Connect Plug
- Lamp Wire Connections: Quick Connect Plug (Female)
- Enclosure: Potted Electrical Components
- Dimensions: 3-3/4"L x 1-1/4" W x 1-3/8" H
- Inverter Life: 50,000 hours
- UL Listed
- The appropriate Inverter will automatically be provided based on the lamp-size requirement.

	MODEL DESCRIPTION	LAMP LENGTH	LAMP COLOR TEMPERATURE	WATT	AMP
Actual size shown (4" CCF). Pictured with two Patented shock absorbing "O" rings.	One-Lamp 4" CCF with Inverter <b>CC-104/41</b>	4"	4100K	5.80w	480mA
	<b>CC-104/50</b>	4"	5050K	5.80w	480mA
	Two-Lamp 4" CCF with Inverter <b>CC-204/41</b>	4"	4100K	8.40w	700mA
	<b>CC-204/50</b>	4"	5050K	8.40w	700mA
	One-Lamp 6" CCF with Inverter <b>CC-106/41</b>	6"	4100K	6.25w	520mA
	<b>CC-106/50</b>	6"	5050K	6.25w	520mA
	Two-Lamp 6" CCF with Inverter <b>CC-206/41</b>	6"	4100K	9.10w	755mA
	<b>CC-206/50</b>	6"	5050K	9.10w	755mA
	One-Lamp 8" CCF with Inverter <b>CC-108/41</b>	8"	4100K	6.75w	560mA
	<b>CC-108/50</b>	8"	5050K	6.75w	560mA
	Two-Lamp 8" CCF with Inverter <b>CC-208/41</b>	8"	4100K	9.75w	810mA
	<b>CC-208/50</b>	8"	5050K	9.75w	810mA
	One-Lamp 10" CCF with Inverter <b>CC-110/41</b>	10"	4100K	7.15w	595mA
	<b>CC-110/50</b>	10"	5050K	7.15w	595mA
	Two-Lamp 10" CCF with Inverter <b>CC-210/41</b>	10"	4100K	10.35w	860mA
	<b>CC-210/50</b>	10"	5050K	10.35w	860mA



Inverter: 3-1/2"L x 1-1/8"W x 3/4" H  
Included with CCF









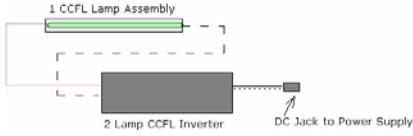

STEP 1. SPECIFY THE NUMBER OF LAMPS, LENGTH AND COLOR TEMPERATURE ... cont'd

	<b>MODEL DESCRIPTION</b>	<b>LAMP LENGTH</b>	<b>LAMP COLOR TEMPERATURE</b>	<b>WATT</b>	<b>AMP</b>
Actual size shown (4" CCF). Pictured with two Patented shock absorbing "O" rings.	One-Lamp 12" CCF with Inverter <b>CC-112/41</b>	12"	4100K	7.55w	630mA
	<b>CC-112/50</b>	12"	5050K	7.55w	630mA
	Two-Lamp 12" CCF with Inverter <b>CC-212/41</b>	12"	4100K	11.00w	910mA
	<b>CC-212/50</b>	12"	5050K	11.00w	910mA
	One-Lamp 14" CCF with Inverter <b>CC-114/41</b>	14"	4100K	8.30w	690mA
	<b>CC-114/50</b>	14"	5050K	8.30w	690mA
	Two-Lamp 14" CCF with Inverter <b>CC-214/41</b>	14"	4100K	11.55w	960mA
	<b>CC-214/50</b>	14"	5050K	11.55w	960mA
	One-Lamp 16" CCF with Inverter <b>CC-116/41</b>	16"	4100K	9.00w	750mA
	<b>CC-116/50</b>	16"	5050K	9.00w	750mA
	Two-Lamp 16" CCF with Inverter <b>CC-216/41</b>	16"	4100K	12.00w	1000mA
	<b>CC-216/50</b>	16"	5050K	12.00w	1000mA
	One-Lamp 18" CCF with Inverter <b>CC-118/41</b>	18"	4100K	9.30w	775mA
	<b>CC-118/50</b>	18"	5050K	9.30w	775mA
	Two-Lamp 18" CCF with Inverter <b>CC-218/41</b>	18"	4100K	12.95w	1080mA
	<b>CC-218/50</b>	18"	5050K	12.95w	1080mA
	One-Lamp 20" CCF with Inverter <b>CC-120/41</b>	20"	4100K	9.60w	800mA
	<b>CC-120/50</b>	20"	5050K	9.60w	800mA
	Two-Lamp 20" CCF with Inverter <b>CC-220/41</b>	20"	4100K	13.95w	1160mA
	<b>CC-220/50</b>	20"	5050K	13.95w	1160mA
	One-Lamp 22" CCF with Inverter <b>CC-122/41</b>	22"	4100K	10.00w	830mA
	<b>CC-122/50</b>	22"	5050K	10.00w	830mA
	Two-Lamp 22" CCF with Inverter <b>CC-222/41</b>	22"	4100K	14.40w	1200mA
	<b>CC-222/50</b>	22"	5050K	14.40w	1200mA
	One-Lamp 24" CCF with Inverter <b>CC-124/41</b>	24"	4100K	10.35w	860mA
	<b>CC-124/50</b>	24"	5050K	10.35w	860mA
	Two-Lamp 24" CCF with Inverter <b>CC-224/41</b>	24"	4100K	14.80w	1240mA
	<b>CC-224/50</b>	24"	5050K	14.80w	1240mA

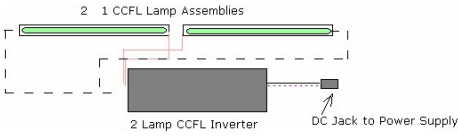
Ordering Instructions:

CC -	<b># LAMPS</b>	<b>LENGTH</b>	<b>COLOR TEMPERATURE</b>
	1 - One Lamp 2 - Two Lamps	04 - 4" 06 - 6" 08 - 8" 10 - 10" 12 - 12" 14 - 14" 16 - 16" 18 - 18" 20 - 20" 22 - 22" 24 - 24"	41 - 4100K (Cool White) 50 - 5050K (Natural)

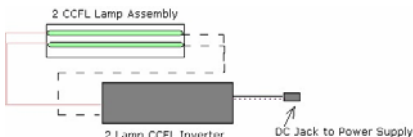
STEP 2. SPECIFY THE LAMP/REFLECTOR CONFIGURATION, AND REFLECTOR TYPE

LAMP/REFLECTOR CONFIGURATION	LAMP/REFLECTOR CONFIGURATION	MOUNTING OPTIONS	X-SECTION VIEW
<b>One-Lamp Fixture</b>	<b>One- Single Configuration</b>		
		<b>CC-1S-CT</b> 1/4" Clear Acrylic Tube with Mounting Clips	
		<b>CC-1S-AEA</b> 1-Lamp Rounded Aluminum Extrusion With Mounting Clips For 1/4" Glass or Acrylic Panels (By others)	
		<b>CC-1S-AEB</b> 1-Lamp Aluminum Extrusion 0.41"W x 0.29"H Downlight 120° Beam Spread	
<b>Two-Lamp Fixture</b>	<b>Two- Single Configuration</b>		
		<b>CC-2S-CT</b> 1/4" Clear Acrylic Tube with Mounting Clips	
		<b>CC-2S-AEA</b> 1-Lamp Rounded Aluminum Extrusion with Mounting Clips For 1/4" Glass or Acrylic Panels (By others)	
		<b>CC-2S-AEB</b> 1-Lamp Aluminum Extrusion with Mounting Clips 0.41"W x 0.29"H Downlight 120° Beam Spread	
	<b>One- Double Configuration</b>		
	<b>CC-1D-AEC</b> 2-Lamp Rounded Aluminum Extrusion with Mounting Clips For 3/8" Glass or Acrylic Panels (By others)		
	<b>CC-1D-AED</b> 2-Lamp Aluminum Extrusion with Mounting Clips 0.41"W x 0.29"H Downlight 120° Beam Spread		

Note:  
Acrylic Tube and Aluminum Extrusion Channels are cut to match the length of the lamp. Tube and Extrusions include patented shock absorbing "O" Rings.





**Ordering Instructions:**

CC –	LAMP/REFLECTOR CONFIGURATION	REFLECTOR OPTION
	1S – One-Lamp (1-Single Configuration)	CT – Clear Acrylic Tube AEA – Aluminum Extrusion "A" AEB – Aluminum Extrusion "B"
	2S – Two-Lamps (2-Single Configuration)	CT – Clear Acrylic Tube AEA – Aluminum Extrusion "A" AEB – Aluminum Extrusion "B"
	1D – Two-Lamps (1-Double Configuration)	AEC – Aluminum Extrusion "C" AED – Aluminum Extrusion "D"

### STEP 3. MATCH UP THE TOTAL WATTAGE TO THE APPROPRIATE POWER SUPPLY





**Switching Power Supply Specifications:**

- Input Voltage: 100v – 240v AC 50/60Hz
- Output Voltage: +12v DC
- Protection: Over Voltage Protection (Output), Over Current Protection (Output), Short Circuit Protection (Output)
- Output Plug: 5.5mm x 2.1mm center positive
- Output Cord: 18 AWG 83" L
- Input Power Cord: DP Series SPT2 18 AWG 72"L
- UL, CSA Listed
- For installations over 2 lamps, please provide installation diagram for proper wiring harness and pricing.

	<b>MODEL DESCRIPTION</b>	<b>DIMENSION</b>	<b>VOLT</b>	<b>WATT</b>
	<b>CC-WP18</b> Wall Plug Power Supply	3-3/8"L x 1-3/4" W x 1-1/4" H	11.4v – 12.6v DC 1.5A	18w
	<b>CC-DP30</b> Desk Top Power Supply	4-1/8"L x 1-7/8" W x 1-3/8" H	11.4v – 12.6v DC 2.5A	30w
	<b>CC-DP55</b> Desk Top Power Supply	4-3/8"L x 2" W x 1-3/8" H	11.4v – 12.6v DC 4.6A	55w
	<b>CC-DP75</b> Desk Top Power Supply	5-1/2"L x 2-3/8" W x 1-3/8" H	11.4v – 12.6v DC 6.2A	75w
	<b>CC-WH</b> Customized Wiring Harness For installations over 2 lamps, please provide installation diagram for proper wiring harness and pricing			

## DISPLAY LIGHTING – XENON MINUET

Energy efficient 1-, 2-, and 3-light Linkable Undercounter Modules are equipped with 12v 20w Xenon lamps that run cooler and lasts up to twenty times longer than halogen lamps, with an average lamp life of 15,000 hours. Units are furnished with 6' cord and plug, and tight-fit direct inline connector, and Hi/Lo rocker switch. Linkable up to 10 units.



	MODEL DESCRIPTION	LAMP	VOLT MAX WATT	FINISH	STD PKG PCS/WGT
	<b>XM111</b> 1-Light Xenon Light Strip 11"L x 3-1/4"W x 1" H	(1) 20w Xenon Lamp Included	12v 20w	WH PB ST	12/25lbs
	<b>XM218</b> 2-Light Xenon Light Strip 18"L x 3-1/4"W x 1" H	(1) 20w Xenon Lamp Included	12v 20w	WH PB ST	12/27lbs
	<b>XM324</b> 3-Light Xenon Light Strip 24"L x 3-1/4"W x 1" H	(1) 20w Xenon Lamp Included	12v 20w	WH PB ST	6/22lbs
	<b>XM-CC6</b> 6" Connecting Cable			WH	12/1lbs
	<b>XM-CC12</b> 12" Connecting Cable			WH	12/1lbs

### Finish Key:

PB Polished Brass  
ST Satin Chrome  
WH White

## DISPLAY LIGHTING – CUP LIGHTS





















Miniature recessed modules (only 3-3/4" diameter) mount quickly and firmly to any cabinet interior using a unique adjustable mounting band. Cup Lights fit the smallest recessed cavity (only 2-7/8" high), making them ideal for any cabinet or merchandise displayer. Lamps not included.

	MODEL DESCRIPTION	LAMP	VOLT MAX WATT	FINISH	STD PKG PCS/WGT
	<b>CUP001</b> Starter Unit 10' Male & 2' Female cords  3-3/4"Ø x 2-7/8"H	Par16, 20, R20	120v 60w	BK, WH CH, PB	36/33lbsg
	<b>CUP002</b> Intermediate Link 2' Male & 2' Female cords  3-3/4"Ø x 2-7/8"H	Par16, 20, R20	120v 60w	BK, WH CH, PB	36/33lbs
	<b>CUP003</b> Tie-in link Starter or end-of-row module 2' Male cord 3-3/4"Ø x 2-7/8"H	Par16, 20, R20	120v 60w	BK, WH CH, PB	36/33lbs

### Finish Key:





BK Black  
CH Chrome  
PB Polished Brass  
WH White

DISPLAY LIGHTING - ARCLIGHTS

DESCRIPTION	FINISH	FIXED MOUNT MODEL	CLAMP MOUNT MODEL	LAMP MAX WATT	STD PKG PCS/WGT
<b>LOW VOLTAGE</b>					
 Low Voltage 111 With 18" Steel Rod 1-5/8"Ø x 2-5/8"L x 6' wire Transformer sold separately	BK, WH ST	 <b>ALFR111</b>	 <b>ALCR111</b>	MR11 12v 35w	24/34lbs
 Low Voltage 123 With 18" Steel Rod 2-1/8"Ø x 2-3/4"L x 6' wire Transformer sold separately	ST	<b>ALFR123</b>	<b>ALCR123</b>	MR16 12v 75w	24/34lbs
 Low Voltage 123 With 12" Gooseneck 2-1/8"Ø x 2-3/4"L x 6' wire Transformer sold separately	ST	<b>N/A</b>	<b>ALCG123-12</b>	MR16 12v 75w	24/34lbs
 Low Voltage 123 With 18" Gooseneck 2-1/8"Ø x 2-3/4"L x 6' wire Transformer sold separately	ST	<b>N/A</b>	<b>ALCG123-18</b>	MR16 12v 75w	24/35lbs
 Low Voltage 123 With 24" Gooseneck 2-1/8"Ø x 2-3/4"L x 6' wire Transformer sold separately	ST	<b>N/A</b>	<b>ALCG123-24</b>	MR16 12v 75w	24/36lbs
 Low Voltage 128 With 18" Steel Rod 1-1/8"Ø x 1-3/4"L x 6' wire	BK, WH ST	<b>ALFR128</b>	<b>ALCR128</b>	MR11 (35w) MR16 (75w) 12v	24/34lbs
 Low Voltage 128 With 12" Gooseneck 1-1/8"Ø x 1-3/4"L x 6' wire Transformer sold separately	ST	<b>N/A</b>	<b>ALCG128-12</b>	MR11 (35w) MR16 (75w) 12v	24/34lbs
 Low Voltage 128 With 18" Gooseneck 1-1/8"Ø x 1-3/4"L x 6' wire Transformer sold separately	ST	<b>N/A</b>	<b>ALCG128-18</b>	MR11 (35w) MR16 (75w) 12v	24/35lbs
 Low Voltage 128 With 24" Gooseneck 1-1/8"Ø x 1-3/4"L x 6' wire Transformer sold separately	ST	<b>N/A</b>	<b>ALCG128-24</b>	MR11 (35w) MR16 (75w) 12v	24/36lbs
 60w Electronic Transformer With 7' cord and AMP Connector		See page 48 for details.	<b>XF60C</b>	12v 10w – 60w	24/6lbs
 80w Electronic Transformer With 7' cord and AMP Connector		See page 48 for details.	<b>XF80C</b>	12v 20w – 80w	24/14lbs
 105w Electronic Transformer With 7' cord and AMP Connector		See page 48 for details.	<b>XF105C</b>	12v 35w – 105w	24/20lbs
 150w Electronic Transformer With 7' cord and AMP Connector		See page 48 for details.	<b>XF150C</b>	12v 35w – 150w	24/20lbs
 210w Electronic Transformer With 7' cord and AMP Connector		See page 48 for details.	<b>XF210C</b>	12v 35w – 210w	24/22lbs
<b>Line Voltage</b>					
 Line Voltage 128 With 18" Steel Rod 1-1/8"Ø x 1-3/4"L With 10' Cord & 3-prong plug	BK, WH ST	<b>AHFR128</b>	<b>AHCR128</b>	MR16 GU10 120v 50w	24/34lbs
 Line Voltage 128 With 12" Gooseneck 1-1/8"Ø x 1-3/4"L With 10' Cord & 3-prong plug	ST	<b>N/A</b>	<b>AHCG128-12</b>	MR16 GU10 120v 50w	24/34lbs
 Line Voltage 128 With 18" Gooseneck 1-1/8"Ø x 1-3/4"L With 10' Cord & 3-prong plug	ST	<b>N/A</b>	<b>AHCG128-18</b>	MR16 GU10 120v 50w	24/35lbs
 Line Voltage 128 With 24" Gooseneck 1-1/8"Ø x 1-3/4"L With 10' Cord & 3-prong plug	ST	<b>N/A</b>	<b>AHCG128-24</b>	MR16 GU10 120v 50w	24/36lbs

**Finish Key:**  
 BK Black  
 ST Satin Chrome  
 WH White

## DISPLAY LIGHTING – HALOGEN PUCK LIGHTS



	<b>MODEL DESCRIPTION</b>	<b>LAMP MAX WATT</b>	<b>FINISH</b>	<b>STD PKG PCS/WGT</b>
	<b>PK100</b> Halogen Metal Puck Light – Round Housing sold separately – see PKC 2-5/8"Ø x 3/4"H	G4 Halogen Bi-Pin 12v 20w (included)	BK, WH CH, PB ST	24/6lbs
	<b>PKC</b> Metal Housing for Round Metal Puck Light – see PK100 Fixture sold separately – see PK100 3"Ø x 1"H		BK, WH CH, PB ST	24/5lbs
	<b>PK200</b> Halogen Plastic Puck Light – Round Housing Included 2-3/4"Ø x 7/8"	G4 Halogen Bi-Pin 12v 20w (included)	BK, WH CH, PB ST	24/5lbs
	<b>PK200X3</b> Halogen Plastic Puck Light Kit Includes (3)PK200, (3)Halogen Lamps, (1)60w Transformer	(3) G4 Halogen Bi-Pin 12v (3) 20w (included)	BK, WH CH, PB ST	6/9lbs
	<b>PK300</b> Halogen Metal Puck Light – Triangle With Built-in Housing 5-1/8"W x 5-1/8"H	G4 Halogen Bi-Pin 12v 20w (included)	ST	24/8lbs

See page 48-49 for transformer selection.

### Finish Key:

BK	Black
CH	Chrome
PB	Polished Brass
ST	Satin Chrome
WH	White

## DISPLAY LIGHTING – XENON PUCK LIGHTS







	<b>MODEL DESCRIPTION</b>	<b>LAMP MAX WATT</b>	<b>FINISH</b>	<b>STD PKG PCS/WGT</b>
	<b>PK100X</b> Xenon Metal Puck Light – Round Housing sold separately – see PKC 2-5/8"Ø x 3/4"H	Xenon Bi-Pin 12v 20w (included)	BK, WH CH, PB ST	24/6lbs
	<b>PKC</b> Metal Housing for Round Metal Puck Light – see PK100X Fixture sold separately – see PK100X 3"Ø x 1"H		BK, WH CH, PB ST	24/5lbs
	<b>PK300X</b> Xenon Metal Puck Light – Triangle With Built-in Housing 5-1/8"W x 5-1/8"H	Xenon Bi-Pin 12v 20w (included)	ST	24/8lbs

See page 48-49 for transformer selection.

### Finish Key:

BK	Black
CH	Chrome
PB	Polished Brass
ST	Satin Chrome
WH	White

## DISPLAY LIGHTING – MINI RECESSED

	<b>MODEL DESCRIPTION</b>	<b>LAMP MAX WATT</b>	<b>FINISH</b>	<b>STD PKG PCS/WGT</b>
	<b>RH30</b> Mini Gimbal Ring with Designer Trim (Lens Included) 3-1/2" Ø x 3/4" EXT 35° adjustability from vertical	MR16 – 12v 75w MR16 GU10 – 120v 50w	BK, WH CH, PB, ST	100/26lbs
	<b>RH25</b> Housing for use with RH30 2-3/4" Ø x 4"H		BK	48/19lbs
	<b>RH34</b> Mini Square Adjustable 3-7/8" x 3-7/8" x 1-1/8" EXT 30° adjustability from vertical	MR16 – 12v 75w MR16 GU10 – 120v 50w	BK, WH	100/34lbs
	<b>RH35</b> Mini Gimbal Ring 2-5/8" Ø x 3/4" EXT 35° adjustability from vertical	MR11 – 12v 35w	BK, WH CH, PB, ST	100/26lbs
	<b>SC-6RND</b> 8" Socket (Round) for MR16 and MR11 lamp		WH	48/4lbs
	<b>SC-30RND</b> 30" Socket (Round) for MR16 and MR11 lamp		WH	48/15lbs
	<b>SC-42RND</b> 42" Socket (Round) for MR16 and MR11 lamp		WH	48/21lbs
	<b>SC-54RND</b> 54" Socket (Round) for MR16 and MR11 lamp		WH	48/27lbs
	<b>SC-6REC</b> 6" Socket (Rectangular) for MR16 and MR11 lamp		WH	48/4lbs
	<b>SC-6GU</b> 6" Socket (Round) for MR16 GU10 lamp		WH	48/4lbs

See page 48-49 for transformer selection.

**Finish Key:**

BK	Black
CH	Chrome
PB	Polished Brass
ST	Satin Chrome
WH	White

## TRANSFORMERS





	<b>MODEL DESCRIPTION</b>	<b>INPUT OUTPUT MIN – MAX WATT</b>	<b>DIMING</b>	<b>STD PKG PCS/WGT</b>
	<b>XF60</b> Electronic Transformer 4-1/8"L x 2-3/8"W x 1-7/8"H	60Hz 120v 12v 10w – 60w	Electronic & Magnetic	24/5lbs
	<b>XF60C</b> Electronic Transformer with 7' Power Cord and AMP Connector 4-1/8"L x 2-3/8"W x 1-7/8"H	60Hz 120v 12v 10w – 60w	Electronic & Magnetic	24/6lbs
	<b>XF80</b> Electronic Transformer 2-5/8"L x 1-3/8"W x 1-1/8"H	60Hz 120v 12v 20w – 80w	Electronic	24/6lbs
	<b>XF80C</b> Electronic Transformer with 7' Power Cord and AMP Connector No Twist, Push Wire Conductor Terminals Included 3-1/4"L x 1-1/2"W x 7/8"H	60Hz 120v 12v 20w – 80w	Electronic & Magnetic	24/14lbs
	<b>XF80S</b> Electronic Transformer – Compact Size No Twist, Push Wire Conductor Terminals Included 2-1/4"L x 1-1/4"W x 7/8"H	60Hz 120v 12v 20w – 80w	Electronic & Magnetic	24/6lbs
	<b>XF105</b> Electronic Transformer 4-3/8"L x 2-7/8"W x 1-1/4"H	60Hz 120v 12v 35w – 105w	Electronic	24/14lbs
	<b>XF105C</b> Electronic Transformer with 7' Power Cord and AMP Connector 4-3/8"L x 2-7/8"W x 1-1/4"H	60Hz 120v 12v 35w – 105w	Electronic & Magnetic	24/20lbs
	<b>XF105D</b> Electronic Transformer No Twist, Push Wire Conductor Terminals Included 4-3/8"L x 2-7/8"W x 1-1/4"H	60Hz 120v 12v 35w – 105w	Electronic & Magnetic	24/14lbs
	<b>XF150</b> Electronic Transformer 4-3/8"L x 2-7/8"W x 1-1/4"H	60Hz 120v 12v 35w – 150w	Electronic	24/14lbs
	<b>XF150C</b> Electronic Transformer with 7' Power Cord and AMP Connector 4-3/8"L x 2-7/8"W x 1-1/4"H	60Hz 120v 12v 35w – 150w	Electronic & Magnetic	24/20lbs
	<b>XF150D</b> Electronic Transformer No Twist, Push Wire Conductor Terminals Included 4-3/8"L x 2-7/8"W x 1-1/4"H	60Hz 120v 12v 35w – 150w	Electronic & Magnetic	24/14lbs
	<b>XF210C</b> Electronic Transformer with 7' Power Cord and AMP Connector 4-1/4"L x 1-7/8"W x 1-1/4"H	60Hz 120v 12v 35w – 210w	Electronic & Magnetic	24/22lbs
	<b>XF210D</b> Electronic Transformer No Twist, Push Wire Conductor Terminals Included 4-1/4"L x 1-7/8"W x 1-1/4"H	60Hz 120v 12v 35w – 210w	Electronic & Magnetic	24/22lbs

TRANSFORMERS ...cont'd

	<b>MODEL DESCRIPTION</b>	<b>INPUT OUTPUT MIN – MAX WATT</b>	<b>DIMING</b>	<b>STD PKG PCS/WGT</b>
	<b>LET75</b> LIGHTTECH Electronic Transformer 2-1/8"L x 1-1/4"W x 3/4"H 4-year Manufacturer's warranty	60Hz 120v 12v 10w – 75w	Electronic	24/6lbs
	<b>LET75-24V</b> LIGHTTECH Electronic Transformer 2-1/8"L x 1-1/4"W x 3/4"H 4-year Manufacturer's warranty	60Hz 120v 24v 10w – 75w	Electronic	24/6lbs
	<b>LET75-277V</b> LIGHTTECH Electronic Transformer 2-1/8"L x 1-1/4"W x 3/4"H 4-year Manufacturer's warranty	60Hz 277v 12v 10w – 75w	Electronic	24/6lbs
	<b>LET151</b> LIGHTTECH Electronic Transformer 3-3/8"L x 1-3/8"W x 1-1/8"H 4-year Manufacturer's warranty	60Hz 120v 12v 50w – 150w	Electronic	24/11lbs
	<b>LET151-24V</b> LIGHTTECH Electronic Transformer 3-3/8"L x 1-3/8"W x 1-1/8"H 4-year Manufacturer's warranty	60Hz 120v 12v 50w – 150w	Electronic	24/11lbs
	<b>LVT151</b> LIGHTTECH Electronic Transformer – Steel Outer Casing 6-1/2"L x 1-1/2"W x 1-3/8"H 4-year Manufacturer's warranty	60Hz 120v 24v 50w – 150w	Electronic	24/33lbs
	<b>LET301</b> LIGHTTECH Electronic Transformer – Round 3-3/4"Ø x 1-3/8"H 4-year Manufacturer's warranty	60Hz 120v 12v 50w – 300w	Electronic	24/26lbs
	<b>LET303</b> LIGHTTECH Electronic Transformer 5-1/4"L x 1-1/2"W x 1-1/8"H 4-year Manufacturer's warranty	60Hz 120v 12v 50w – 300w	Electronic	24/20lbs
	<b>LET303-24V</b> LIGHTTECH Electronic Transformer 5-1/4"L x 1-1/2"W x 1-1/8"H 4-year Manufacturer's warranty	60Hz 120v 24v 50w – 300w	Electronic	24/20lbs
	<b>LVT303</b> LIGHTTECH Electronic Transformer – Steel Outer Casing 9-3/8"L x 1-5/8"W x 1-1/2"H 4-year Manufacturer's warranty	60Hz 120v 12v 50w – 300w	Electronic	24/36lbs
	<b>XF50T</b> Torroidal Magnetic Transformer 3"Ø x 1"H	50/60Hz 120v 12v 50w	Magnetic	12/16lbs
	<b>XF75T</b> Torroidal Magnetic Transformer 3"Ø x 1"H	50/60Hz 120v 12v 75w	Magnetic	12/16lbs
	<b>XF100T</b> Torroidal Magnetic Transformer 3-3/4"Ø x 1-1/4"H	50/60Hz 120v 12v 100w	Magnetic	12/28lbs
	<b>XF150T</b> Torroidal Magnetic Transformer 4"Ø x 1-3/8"H	50/60Hz 120v 12v 150w	Magnetic	12/44lbs
	<b>XF200T</b> Torroidal Magnetic Transformer 4"Ø x 1-3/4"H	50/60Hz 120v 12v 200w	Magnetic	12/51lbs
	<b>XF250T</b> Torroidal Magnetic Transformer 4-3/4"Ø x 1-1/2"H	50/60Hz 120v 12v 250w	Magnetic	12/57lbs
	<b>XF300T</b> Torroidal Magnetic Transformer 4-3/4"Ø x 1-3/4"H	50/60Hz 120v 12v 300w	Magnetic	8/48lbs
	<b>XF500T</b> Torroidal Magnetic Transformer 5-1/2"Ø x 2-1/4"H	50/60Hz 120v 12v 500w	Magnetic	6/54lbs

## DECORATIVES – FLOATING GLASS SERIES – CABLE HUNG

Modular decorative luminaries designed for cable hung, stem mounted or surface (close-to-ceiling) options. Custom configurations available upon request – consult factory.





	<b>MODEL DESCRIPTION</b>	<b>LAMP MAX WATT</b>	<b>FINISH</b>	<b>STD PKG PCS/WGT</b>
	<b>C207H</b> Glass Pendant – Single Tier – Cable Hung (35") With (1) 12" Tempered Glass Disc	Medium Base Halogen lamp 120v 100w (included)	BK, WH ST	1/8lbs
	<b>C240H</b> Glass Pendant – Single Tier – Cable Hung (35") With (1) 16" Tempered Glass Disc	Medium Base Halogen lamp 120v 100w (included)	BK, WH ST	1/9lbs
	<b>C208H</b> Glass Pendant – Single Tier – Cable Hung (35") With (1) 19-1/2" Tempered Glass Disc	Medium Base Halogen lamp 120v 100w (included)	BK, WH ST	1/11lbs
	<b>C241H</b> Glass Pendant – Double Tier – Cable Hung (35") With (1) 16" and (1) 12" Tempered Glass Disc	Medium Base Halogen lamp 120v 100w (included)	BK, WH ST	1/12lbs
	<b>C229H</b> Glass Pendant – Double Tier – Cable Hung (35") With (1) 19-1/2" and (1) 12" Tempered Glass Disc	Medium Base Halogen lamp 120v 100w (included)	BK, WH ST	1/14lbs
	<b>C243H</b> Glass Pendant – Double Tier – Cable Hung (35") With (1) 19-1/2" and (1) 16" Tempered Glass Disc	Medium Base Halogen lamp 120v 100w (included)	BK, WH ST	1/15lbs
	<b>C227H</b> Glass Pendant – Double Tier – Cable Hung (35") With (2) 12" Tempered Glass Disc	Medium Base Halogen lamp 120v 100w (included)	BK, WH ST	1/12lbs
	<b>C242H</b> Glass Pendant – Double Tier – Cable Hung (35") With (2) 16" Tempered Glass Disc	Medium Base Halogen lamp 120v 100w (included)	BK, WH ST	1/14lbs
	<b>C228H</b> Glass Pendant – Double Tier – Cable Hung (35") With (2) 19-1/2" Tempered Glass Disc	Medium Base Halogen lamp 120v 100w (included)	BK, WH ST	1/15lbs
	<b>C233H</b> Glass Pendant – Triple Tier – Stem Mounted With (1) 19-1/2", (1) 16" and (1) 12" Tempered Glass Disc	Medium Base Halogen lamp 120v 100w (included)	BK, WH ST	1/18lbs

Custom configurations available upon request – consult factory.

**Finish Key:**

BK Black  
ST Satin Chrome  
WH White

DECORATIVES – FLOATING GLASS SERIES – SURFACE MOUNTED

	<b>MODEL DESCRIPTION</b>	<b>LAMP MAX WATT</b>	<b>FINISH</b>	<b>STD PKG PCS/WGT</b>
	<b>C207F</b> Glass Fixture – Single Tier – Surface Mounted With (1) 12" Tempered Glass Disc	Medium Base Halogen lamp 120v 100w (included)	BK, WH ST	1/8lbs
	<b>C240F</b> Glass Fixture – Single Tier – Surface Mounted With (1) 16" Tempered Glass Disc	Medium Base Halogen lamp 120v 100w (included)	BK, WH ST	1/9lbs
	<b>C208F</b> Glass Fixture – Single Tier – Surface Mounted With (1) 19-1/2" Tempered Glass Disc	Medium Base Halogen lamp 120v 100w (included)	BK, WH ST	1/11lbs
	<b>C241F</b> Glass Fixture – Double Tier – Surface Mounted With (1) 16" and (1) 12" Tempered Glass Disc	Medium Base Halogen lamp 120v 100w (included)	BK, WH ST	1/12lbs
	<b>C229F</b> Glass Fixture – Double Tier – Surface Mounted With (1) 19-1/2" and (1) 12" Tempered Glass Disc	Medium Base Halogen lamp 120v 100w (included)	BK, WH ST	1/14lbs
	<b>C243F</b> Glass Fixture – Double Tier – Surface Mounted With (1) 19-1/2" and (1) 16" Tempered Glass Disc	Medium Base Halogen lamp 120v 100w (included)	BK, WH ST	1/15lbs
	<b>C227F</b> Glass Fixture – Double Tier – Surface Mounted With (2) 12" Tempered Glass Disc	Medium Base Halogen lamp 120v 100w (included)	BK, WH ST	1/12lbs
	<b>C242F</b> Glass Fixture – Double Tier – Surface Mounted With (2) 16" Tempered Glass Disc	Medium Base Halogen lamp 120v 100w (included)	BK, WH ST	1/14lbs
	<b>C228F</b> Glass Fixture – Double Tier – Surface Mounted With (2) 19-1/2" Tempered Glass Disc	Medium Base Halogen lamp 120v 100w (included)	BK, WH ST	1/15lbs
	<b>C233F</b> Glass Pendant – Triple Tier – Surface Mounted With (1) 19-1/2", (1) 16" and (1) 12" Tempered Glass Disc	Medium Base Halogen lamp 120v 100w (included)	BK, WH ST	1/18lbs

Custom configurations available upon request – consult factory.























**Finish Key:**

BK Black  
ST Satin Chrome  
WH White

DECORATIVES – CEILING FIXTURES – 1-LIGHT & 3-LIGHT LOW VOLTAGE FIXTURES

DESCRIPTION LAMP	FINISH		1-LIGHT FIXTURE DIMENSION		3-LIGHT FIXTURE DIMENSION	STD PKG PCS/WGT
Accordian – Die Cast With 50w Built-in Electronic Transformer(s) Lamp: MR16 12v 50w	BK, WH		<b>LT1100</b> 4¾"Ø x 7"Max Ext		<b>LT3100</b> 10½"Ø x 7¼"Max Ext	1-LGT 24/31lbs  3-LGT 6/28lbs
Soft Square – Die Cast With 50w Built-in Electronic Transformer(s) Lamp: MR16 12v 50w	BK, WH ST		<b>LT1102</b> 4¾"Ø x 5¾"Max Ext		<b>LT3102</b> 10½"Ø x 6"Max Ext	1-LGT 24/31lbs  3-LGT 6/28lbs
Net – Die Cast With 50w Built-in Electronic Transformer(s) Lamp: MR16 12v 50w	BK, WH		<b>LT1104</b> 4¾"Ø x 6½"Max Ext		<b>LT3104</b> 10½"Ø x 6¾"Max Ext	1-LGT 24/31lbs  3-LGT 6/28lbs
Saturn – Die Cast With 50w Built-in Electronic Transformer(s) Lamp: MR16 12v 50w	BK, WH ST  With Clear Acrylic Disk		<b>LT1106</b> 4¾"Ø x 6¾"Max Ext		<b>LT3106</b> 10½"Ø x 7"Max Ext	1-LGT 24/31lbs  3-LGT 6/28lbs
Tropic Glass – Die Cast With 50w Built-in Electronic Transformer(s) Lamp: MR16 12v 50w	BK, WH  Glass Options: BU, FR		<b>LT1107</b> 4¾"Ø x 6"Max Ext		<b>LT3107</b> 10½"Ø x 6¼"Max Ext	1-LGT 24/31lbs  3-LGT 6/28lbs
Classic – Die Cast With 50w Built-in Electronic Transformer(s) Lamp: MR16 12v 50w	BK, WH		<b>LT1108</b> 4¾"Ø x 6"Max Ext		<b>LT3108</b> 10½"Ø x 6¼"Max Ext	1-LGT 24/31lbs  3-LGT 6/28lbs
Round – Die Cast With 50w Built-in Electronic Transformer(s) Lamp: MR16 12v 50w	BK, WH ST		<b>LT1109</b> 4¾"Ø x 5¾"Max Ext		<b>LT3109</b> 10½"Ø x 6"Max Ext	1-LGT 24/31lbs  3-LGT 6/28lbs
Roundback Step Baffle With 50w Built-in Electronic Transformer(s) Lamp: MR16 12v 50w	BK, WH		<b>LT1110</b> 4¾"Ø x 6¾"Max Ext		<b>LT3110</b> 10½"Ø x 7"Max Ext	1-LGT 24/31lbs  3-LGT 6/28lbs
Pendulum With 50w Built-in Electronic Transformer(s) Lamp: MR16 12v 50w	BK, WH ST Glass Options: AM, BU, FR, GN		<b>LT1113</b> 4¾"Ø x 51"Max Ext  Cable 48"		<b>LT3113</b> 10½"Ø x 51"Max Ext  Cable 48"	1-LGT 24/31lbs  3-LGT 6/28lbs
Conical Pendulum With 50w Built-in Electronic Transformer(s) Lamp: MR16 12v 50w	BK, WH ST Glass Options: AM, BU, FR		<b>LT1114</b> 4¾"Ø x 51"Max Ext  Cable 48"		<b>LT3114</b> 10½"Ø x 51"Max Ext  Cable 48"	1-LGT 24/31lbs  3-LGT 6/28lbs
Glass Disk – Die Cast With 50w Built-in Electronic Transformer(s) Lamp: MR16 12v 50w	BK, WH  With Frosted Glass Disk		<b>LT1115</b> 4¾"Ø x 6¾"Max Ext		<b>LT3115</b> 10½"Ø x 6½"Max Ext	1-LGT 24/31lbs  3-LGT 6/28lbs

DECORATIVES - CEILING FIXTURES - 1-LIGHT & 3-LIGHT LOW VOLTAGE FIXTURES ... cont'd

DESCRIPTION LAMP	FINISH		1-LIGHT FIXTURE DIMENSION PRICE		3-LIGHT FIXTURE DIMENSION PRICE	STD PKG PCS/WGT
Star Ship – Die Cast With 50w Built-in Electronic Transformer(s) Lamp: MR16 12v 50w	BK, WH  Glass Options: BU, FR		<b>LT1116</b> 4¾"Ø x 6"Max Ext		<b>LT3116</b> 10½"Ø x 6¾"Max Ext	1-LGT 24/31lbs  3-LGT 6/28lbs
Olympic – Die Cast With 50w Built-in Electronic Transformer(s) Lamp: MR16 12v 50w	PBST, ST		<b>LT1120</b> 4¾"Ø x 6¾"Max Ext 23.00		<b>LT3120</b> 10½"Ø x 6½"Max Ext	1-LGT 24/31lbs  3-LGT 6/28lbs
Glass Tech – Die Cast With 50w Built-in Electronic Transformer(s) Lamp: MR16 12v 50w	CH ST Glass Options: AM, BU, FR, GN, PK		<b>LT1122</b> 4¾"Ø x 6½"Max Ext		<b>LT3122</b> 10½"Ø x 6¾"Max Ext  *Chrome fixture, Satin Chrome canopy	1-LGT 24/27lbs  3-LGT 6/27lbs
Rocket – Die Cast With 50w Built-in Electronic Transformer(s) Lamp: MR16 12v 50w	ST		<b>LT1123</b> 4¾"Ø x 5"Max Ext		<b>LT3123</b> 10½"Ø x 5¼"Max Ext	1-LGT 24/27lbs  3-LGT 6/22lbs
Spurs – Die Cast With 50w Built-in Electronic Transformer(s) Lamp: MR16 12v 50w	ST		<b>LT1127</b> 4¾"Ø x 6¾"Max Ext		<b>LT3127</b> 10½"Ø x 6½"Max Ext	1-LGT 24/22lbs  3-LGT 6/23lbs
Step Baffle – Die Cast With 50w Built-in Electronic Transformer(s) Lamp: MR16 12v 50w	BK, WH		<b>LT1130</b> 4¾"Ø x 6¾"Max Ext		<b>LT3130</b> 10½"Ø x 6½"Max Ext	1-LGT 24/31lbs  3-LGT 6/28lbs
Gimbal With 50w Built-in Electronic Transformer(s) Lamp: MR16 12v 50w	BK, WH ST		<b>LT1132</b> 4¾"Ø x 5¼"Max Ext		<b>LT3132</b> 10½"Ø x 5½" Max Ext	1-LGT 24/31lbs  3-LGT 6/28lbs
Renaissance – Die Cast With 50w Built-in Electronic Transformer(s) Lamp: MR16 12v 50w	ST  Glass Options: AM, BU, FR		<b>LT1138</b> 4¾"Ø x 6½"Max Ext		<b>LT3138</b> 10½"Ø x 6¾"Max Ext	1-LGT 24/25lbs  3-LGT 6/31lbs
Bullet – Die Cast With 50w Built-in Electronic Transformer(s) Lamp: MR16 12v 50w	BK, WH ST		<b>LT1140</b> 4¾"Ø x 6½"Max Ext		<b>LT3140</b> 10½"Ø x 6¾"Max Ext	1-LGT 24/31lbs  3-LGT 6/28lbs
Gimbal Plus – Die Cast With 50w Built-in Electronic Transformer(s) Lamp: MR16 12v 50w	BK, WH ST		<b>LT1143</b> 4¾"Ø x 6¼"Max Ext		<b>LT3143</b> 10½"Ø x 6½"Max Ext	1-LGT 24/32lbs  3-LGT 6/23lbs
Tropic – Die Cast With 50w Built-in Electronic Transformer(s) Lamp: MR16 12v 50w	ST  Glass Options: AM, BU, FR		<b>LT1147</b> 4¾"Ø x 6½"Max Ext		<b>LT3147</b> 10½"Ø x 6¾"Max Ext	1-LGT 24/31lbs  3-LGT 6/28lbs

DECORATIVES – CEILING FIXTURES – 1-LIGHT & 3-LIGHT LOW VOLTAGE FIXTURES ... cont'd

DESCRIPTION LAMP	FINISH		1-LIGHT FIXTURE DIMENSION PRICE		3-LIGHT FIXTURE DIMENSION PRICE	STD PKG PCS/WGT
Stylite Round – Die Cast With 50w Built-in Electronic Transformer(s) Lamp: AR111 12v 50w (included)	BK, WH ST		<b>LT1151</b> 4¾"Ø x 7¾"Max Ext		N/A	1-LGT 24/31lbs
Stylite Square – Die Cast With 50w Built-in Electronic Transformer(s) Lamp: AR111 12v 50w (included)	BK, WH ST		<b>LT1152</b> 4¾"Ø x 8½"Max Ext		N/A	1-LGT 24/31lbs
Plano With 50w Built-in Electronic Transformer(s) Lamp: MR16 12v 50w	ST		<b>LT1240</b> 4¾"Ø x 6¾"Max Ext		<b>LT3240</b> 10½"Ø x 7"Max Ext	1-LGT 24/31lbs  3-LGT 6/28lbs
Saucer With 50w Built-in Electronic Transformer(s) Lamp: MR16 12v 50w	CH  Glass Options: AM, BU, FR		<b>LT1806</b> 4¾"Ø x 6¾"Max Ext  (Chrome fixture & Chrome canopy)		<b>LT3806</b> 10½"Ø x 7"Max Ext  (Chrome fixture & Satin Chrome canopy)	1-LGT 24/31lbs  3-LGT 6/28lbs

**Finish Key – Fixtures:**

BK: Black  
 CH: Chrome  
 PBST: Polished brass/Satin Chrome (2-tone)  
 ST: Satin Chrome  
 WH: White

**Finish Key – Glass Options:**

AM: Amber  
 BU: Blue  
 FR: Frosted  
 GN: Green  
 PK: Pink

DECORATIVES – CEILING FIXTURES – 1-LIGHT & 3-LIGHT LINE VOLTAGE FIXTURES

DESCRIPTION LAMP	FINISH		1-LIGHT FIXTURE DIMENSION PRICE		3-LIGHT FIXTURE DIMENSION PRICE	STD PKG PCS/WGT
Spurs – Die Cast Lamp: MR16 GU10 12v 50w (included)	ST		<b>HT1127</b> 4¾"Ø x 6¼"Max Ext		<b>HT3127</b> 10½"Ø x 6½"Max Ext	1-LGT 24/31lbs  3-LGT 6/28lbs
Renaissance – Die Cast Lamp: MR16 GU10 12v 50w (included)	ST  Glass Options: AM, BU, FR		<b>HT1138</b> 4¾"Ø x 6½"Max Ext		<b>HT3138</b> 10½"Ø x 6¾"Max Ext	1-LGT 24/31lbs  3-LGT 6/28lbs
Plano Lamp: MR16 GU10 12v 50w (included)	ST		<b>HT1240</b> 4¾"Ø x 6¾"Max Ext		<b>HT3240</b> 10½"Ø x 7"Max Ext	1-LGT 24/31lbs  3-LGT 6/28lbs

**Finish Key – Fixtures:**  
ST: Satin Chrome

**Finish Key – Glass Options:**  
AM: Amber  
BU: Blue  
FR: Frosted

DECORATIVES – CEILING FIXTURES – 1-LIGHT LOW & LINE VOLTAGE FIXTURES – EXTENDERS

	ROD FIXTURE EXTENDER		GOOSENECK FIXTURE EXTENDER	
	MODEL	FINISH	MODEL	FINISH
	DESCRIPTION		DESCRIPTION	
	<b>SK212</b>	BK, WH ST	<b>GN212</b>	ST
	12" Rod Fixture Extender		12" Gooseneck Fixture Extender	
	<b>SK218</b>	BK, WH ST	<b>GN218</b>	ST
	18" Rod Fixture Extender		18" Gooseneck Fixture Extender	
	<b>SK224</b>	BK, WH ST	<b>GN224</b>	ST
	24" Rod Fixture Extender		24" Gooseneck Fixture Extender	
	<b>SK236</b>	BK, WH ST		
	36" Rod Fixture Extender			
	<b>SK248</b>	BK, WH ST		
	48" Rod Fixture Extender			

**Pricing:**  
Available as a complete unit from the factory. When ordering, please specify fixture style, extension type and length.

**Finish Key:**  
BK: Black  
ST: Satin Chrome  
WH: White





## OUTDOOR – GEMSTEEL STAINLESS STEEL SURFACES

The Gemsteel collection of stainless steel indoor/outdoor luminaries creates dramatic accents for interior architecture, exquisite landscape concepts and urban site design.

### Features:



- High gloss brushed stainless steel.
- Lamp: 60w max, 120v E27 base.
- Weatherability for marine and salt spray, chemical and other injurious environments.
- Fully gasketed and sealed to prevent moisture.
- Weather-tight, ideal for wet and damp locations.
- Prewired – ready for quick connection.

## OUTDOOR – GEMSTEEL WALL MEDIA

	MODEL DESCRIPTION	MATERIAL	LAMP MAX WATT	STD PKG PCS/WGT
	<b>GS10S51</b> Wall Media 51 – Wall Sconce 11-7/8”L x 8-5/8”W x 3-1/2”D	Brushed stainless steel With Opal White Acrylic	E27 base 120v 60w	6/19lbs
	<b>GS10S70</b> Wall Media 70 – Wall Sconce 11-7/8”L x 8-5/8”W x 3-1/2”D	Brushed stainless steel With Opal White Acrylic	E27 base 120v 60w	6/16lbs
	<b>GS10S71</b> Wall Media 71 – Wall Sconce 11-7/8”L x 8-5/8”W x 3-1/2”D	Brushed stainless steel With Opal White Acrylic	E27 base 120v 60w	6/19lbs
	<b>GS10S72</b> Wall Media 72 – Wall Sconce 11-7/8”L x 8-5/8”W x 3-1/2”D	Brushed stainless steel With Opal White Acrylic	E27 base 120v 60w	6/19lbs
	<b>GS10S81</b> Wall Media 81 – Wall Sconce 11-7/8”L x 8-5/8”W x 3-1/2”D	Brushed stainless steel With Opal White Acrylic	E27 base 120v 60w	6/18lbs







## OUTDOOR – GEMSTEEL BEAMERS

A clean line of brushed steel surfaces to delineate directional boundaries and enhance environmental design. Beamer bollards feature all the structural benefits of stainless steel construction, yet include the best features of graceful styling.







	MODEL DESCRIPTION	MATERIAL	LAMP MAX WATT	STD PKG PCS/WGT
	<b>GS20S52</b> Wall Angle 52 3”Ø x 15-7/8”L x 7”D	Brushed stainless steel	E27 base 120v 60w	6/16lbs
	<b>GS20S53</b> Low Mounted Bollard 53 Base 5-1/8”Ø x 17-3/4”H	Brushed stainless steel	E27 base 120v 60w	6/21lb
	<b>GS20S54</b> High Mounted Bollard 54 Base 5-1/8”Ø x 43-1/2”H	Brushed stainless steel	E27 base 120v 60w	6/45lbs
	<b>GS20S66</b> High Mounted 3-Level Bollard 66 Base 11-7/8”Ø x (1) 43-1/2”H; (1) 55”H; (1) 67”H	Brushed stainless steel	E27 base 120v 60w	1/24lbs

## OUTDOOR – GEMSTEEL TRI-BAFFLE MONITORS







GemSteel Monitor profiles are provided for wall or surface mounted options, as well as single 2-Light and 3-Light pole mounted options. Durable, non-corrosive stainless steel patterns enhance patios and gardens, trees and plants, modern or classic sculpture and a broad array of commercial and residential spaces.

	<b>MODEL DESCRIPTION</b>	<b>MATERIAL</b>	<b>LAMP MAX WATT</b>	<b>STD PKG PCS/WGT</b>
	<b>GS30S03</b> Wall Up Light 13-5/8"H x 8-3/8" x 9-1/2"D	Brushed stainless steel	E27 base 120v 60w	6/24lbs
	<b>GS30S04</b> Wall Down Light 13-5/8"H x 8-3/8"W x 9-1/2"D	Brushed stainless steel	E27 base 120v 60w	6/24lbs
	<b>GS30S06</b> Low Post 19-3/4"H x 8-3/8" top Ø	Brushed stainless steel	E27 base 120v 60w	1/9lbs
	<b>GS30S07</b> Medium Post 41-3/8"H x 8-3/8" top Ø	Brushed stainless steel	E27 base 120v 60w	1/15lbs
	<b>GS30S64</b> 2-Light High Post 78"H	Brushed stainless steel	E27 base 120v 60w	1/20lbs
	<b>GS30S65</b> 3-Light High Post 78"H	Brushed stainless steel	E27 base 120v 60w	1/24lbs





## OUTDOOR – GEMSTEEL FIVE-BAFFLE MONITORS

	<b>MODEL DESCRIPTION</b>	<b>MATERIAL</b>	<b>LAMP MAX WATT</b>	<b>STD PKG PCS/WGT</b>
	<b>GS40S15</b> Wall Up Light 14"H x 8-1/4"W x 9-1/2"D	Brushed stainless steel	E27 base 120v 60w	6/24lbs
	<b>GS40S16</b> Wall Down Light 14"H x 8-1/4"W x 9-1/2"D	Brushed stainless steel	E27 base 120v 60w	6/24lbs
	<b>GS40S57</b> Wall Angle 3"Ø x 15-7/8"L x 7"D	Brushed stainless steel	E27 base 120v 60w	6/22lbs
	<b>GS40S17</b> Low Post 19-3/4"H x 8-1/4" top Ø	Brushed stainless steel	E27 base 120v 60w	1/14lbs
	<b>GS40S18</b> Medium Post 39-3/8"H x 8-1/4" top Ø	Brushed stainless steel	E27 base 120v 60w	1/16lbs
	<b>GS40S58</b> Low Mounted Bollard 58 Base 5-1/8"Ø x 17-3/4"H	Brushed stainless steel	E27 base 120v 60w	1/15lbs
	<b>GS40S59</b> High Mounted Bollard 59 Base 5-1/8"Ø x 43-3/8"H	Brushed stainless steel	E27 base 120v 60w	1/18lbs

OUTDOOR – MOONGLO GLOBE SERIES

	<b>MODEL DESCRIPTION</b>	<b>MATERIAL</b>	<b>LAMP MAX WATT</b>	<b>STD PKG PCS/WGT</b>
	<b>GS50S67W</b> Moonglo Wall Axis with Opal White Globe 11-1/4"H x 10"W x 11-1/8"D	Brushed stainless steel Opal White Acrylic Globe	E27 base 120v 60w	6/23lbs
	<b>GS50S67C</b> Moonglo Wall Axis with Clear Acrylic Globe 11-1/4"H x 10"W x 11-1/8"D	Brushed stainless steel Clear Acrylic Globe	E27 base 120v 60w	6/23lbs
	<b>GS50S68W</b> Moonglo Wall Axis with Opal White Globe 11-1/4"H x 8"W x 10-3/8"D	Brushed stainless steel Opal White Acrylic Globe	E27 base 120v 60w	6/22lbs
	<b>GS50S68C</b> Moonglo Wall Axis with Clear Acrylic Globe 11-1/4"H x 8"W x 10-3/8"D	Brushed stainless steel Clear Acrylic Globe	E27 base 120v 60w	6/22lbs
	<b>GS50S32</b> Moonglo Low Post with Opal White Acrylic Globe 19-3/4"H x 8" Globe Ø	Brushed stainless steel Opal White Acrylic Globe	E27 base 120v 60w	1/10lbs
	<b>GS50S33</b> Moonglo High Post with Opal White Acrylic Globe 43-3/8"H x 8" Globe Ø	Brushed stainless steel	E27 base 120v 60w	1/20lbs

OUTDOOR – SPECIALTIES

	<b>MODEL DESCRIPTION</b>	<b>MATERIAL</b>	<b>LAMP MAX WATT</b>	<b>STD PKG PCS/WGT</b>
	<b>GS10S69</b> Top Castle Wall Sconce 11-7/8"H x 8-5/8"W x 8"D	Brushed stainless steel	E27 base 120v 60w	6/26lbs
	<b>GS60S50</b> Pyramid for Wall or Ceiling Mount 11-1/4"Ø" x 5"D	Brushed stainless steel	E27 base 120v 60w	6/25lbs
	<b>GS30S156</b> Tri-Baffle Solar (spike mounted) with LED lighting. High coil conversion efficiency. Rechargeable battery. 20-1/2"H x 5-1/2" top Ø	Brushed stainless steel	LED Lamp Source	6/26lbs
	<b>GS90S60</b> Gem Steel Mailbox 18"L x 12-5/8"W x 5-1/4"H	Brushed stainless steel		6/20lbs

## LAMPS – HALOGEN LAMPS – JC BI-PIN

Color Temperature: 2900K

Average Life: 2000 Hours

Burning Position: Any



MODEL	LENGTH	VOLT	WATT	LUMENS	BASE	INNER PK/ MASTER CTN
JC-10	1-1/4"	12v	10w	140	G4	20/200
JC-20	1-1/4"	12v	20w	330	G4	20/200
JC-35	1-3/4"	12v	35w	650	GY6.35	20/200
JC-50	1-3/4"	12v	50w	950	GY6.35	20/200
JC-75	1-3/4"	12v	75w	1400	GY6.35	20/200

## LAMPS – HALOGEN LAMPS – MR16 DICHROIC REFLECTOR

Color Temperature: 3000K

Average Life: 3000 Hours

Burning Position: Any



MODEL	VOLT	WATT	CBCP	BASE	BEAM ANGLE	INNER PK/ MASTER CTN
MR16-20ESX	12v	20w	4100	GU5.3	12	10/200
MR16-20BAB	12v	20w	850	GU5.3	36	10/200
MR16-20BAB-L (Lensed)	12v	20w	850	GU5.3	36	10/200
MR16-35FMT	12v	35w	6300	GU5.3	12	10/200
MR16-35FMW	12v	35w	1550	GU5.3	36	10/200
MR16-50EXT	12v	50w	9150	GU5.3	13	10/200
MR16-50EXZ	12v	50w	3000	GU5.3	24	10/200
MR16-50EXN	12v	50w	1500	GU5.3	36	10/200
MR16-50EXN-L (Lensed)	12v	50w	1500	GU5.3	36	10/200
MR16-50EXN-MB*	12v	50w	1500	GU5.3	36	10/300
MR16-50EXN-L-MB* (Lensed)	12v	50w	1500	GU5.3	36	10/300
MR16-75EYF	12v	75w	10900	GU5.3	14	10/200
MR16-75EYF-L (Lensed)	12v	75w	10900	GU5.3	14	10/200
MR16-75EYC	12v	75w	2000	GU5.3	40	10/200
MR16-75EYC-L (Lensed)	12v	75w	2000	GU5.3	40	10/200

\*Major Brand

## LAMPS – HALOGEN LAMPS – MR11 DICHROIC REFLECTOR

Color Temperature: 3000K

Average Life: 3000 Hours

Burning Position: Any



MODEL	VOLT	WATT	CBCP	BASE	BEAM ANGLE	INNER PK/ MASTER CTN
MR11-20FTD	12v	20w	700	GU4	30	10/200
MR11-20FTD-L (Lensed)	12v	20w	700	GU4	30	10/200
MR11-35FTH	12v	35w	1500	GU4	30	10/200
MR11-35FTH-L (Lensed)	12v	35w	1500	GU4	30	10/200

## LAMPS – HALOGEN LAMPS – DICHROIC REFLECTOR FOR LINE VOLTAGE

Color Temperature: 3000K

Average Life: 3000 Hours

Burning Position: Any



MODEL	VOLT	WATT	MBCP	BASE	BEAM ANGLE	INNER PK/ MASTER CTN
GU10-50-L (Lensed)	120v	50w	700	GU10	38	20/200
GU10-75-L (Lensed)	120v	75w	700	GU10	38	20/200
GU10-50-L-MB* (Lensed)	120v	50w	700	GU10	38	10/300
GZ10-50-L-MB* (Lensed)	120v	50w	700	GZ10	38	10/300

\*Major Brand

## LAMPS – HALOGEN PAR LAMPS – PAR20

Average Life: 2000 Hours

Burning Position: Any

	MODEL	VOLT	WATT	MBCP	LUMENS	BEAM ANGLE	BASE	MOL	INNER PK/ MASTER CTN
	50PAR20-NSP9	120v	50w	4150	550	N.Spot 9°	Med.	3-3/8"	1/12
	50PAR20-SP16	120v	50w	2650	550	Spot 16°	Med.	3-3/8"	1/12
	50PAR20-NFL30	120v	50w	1100	550	N.Flood 30°	Med.	3-3/8"	1/12

## LAMPS – HALOGEN PAR LAMPS – PAR30L (LONG NECK)

Average Life: 2500 Hours

Burning Position: Any

	MODEL	VOLT	WATT	MBCP	LUMENS	BEAM ANGLE	BASE	MOL	INNER PK/ MASTER CTN
	75PAR30L-NSP9	120v	75w	13000	1050	N.Spot 9°	Med.	4-1/2"	1/6
	75PAR30L-SP16	120v	75w	6900	1050	Spot 16°	Med.	4-1/2"	1/6
	75PAR30L-NFL30	120v	75w	3700	1050	N.Flood 30°	Med.	4-1/2"	1/6
	75PAR30L-FL40	120v	75w	1800	1050	Flood 40°	Med.	4-1/2"	1/6

## LAMPS – HALOGEN PAR LAMPS – PAR38

Average Life: 2500 Hours

Burning Position: Any

	MODEL	VOLT	WATT	MBCP	LUMENS	BEAM ANGLE	BASE	MOL	INNER PK/ MASTER CTN
	75PAR38-NSP8	130v	75w	19000	1100	N.Spot 8°	Med.	5-3/8"	1/6
	75PAR38-SP10	120v	75w	14000	1100	Spot 10°	Med.	5-3/8"	1/6
	75PAR38-FL28	120v	75w	5000	1100	Flood 28°	Med.	5-3/8"	1/6
	90PAR38-SP12	120v	90w	14500	1350	Spot 12°	Med.	5-3/8"	1/6
	90PAR38-FL28	120v	90w	4500	1350	Flood 28°	Med.	5-3/8"	1/6

## LAMPS – XENON LAMPS – BI-PIN LAMPS

Color Temperature: 2900K

Average Life: 5,000 Hours

Burning Position: Any

	MODEL	VOLT	WATT	LUMENS	BASE	INNER PK/ MASTER CTN
	XL20-CL (Clear)	12v	20w	200	Bi-Pin G4	10/50
	XL20-FR (Frosted)	12v	20w	200	Bi-Pin G4	10/50

LAMPS – COMPACT FLUORESCENT LAMPS – PL-C CLUSTER 4-PIN FLUORESCENT LAMPS\*

Average Life: 10,000 Hours

Burning Position: Any

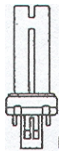

MODEL	VOLT	WATT	COLOR TEMP	INITIAL LUMENS	DESIGN LUMENS	CRI	MOL	BASE	INNER PK/ MASTER CTN
PLC-13W/830	120v	13w	3000K	900	775	82	5-7/8"	G24Q-1	1/12
PLC-13W/835	120v	13w	3500K	900	775	82	5-7/8"	G24Q-1	1/12
PLC-13W/841	120v	13w	4100K	900	775	82	5-7/8"	G24Q-1	1/12
PLC-18W/830	120v	18w	3000K	1250	1075	82	5-3/4"	G24Q-2	1/12
PLC-18W/835	120v	18w	3500K	1250	1075	82	5-3/4"	G24Q-2	1/12
PLC-18W/841	120v	18w	4100K	1250	1075	82	5-3/4"	G24Q-2	1/12
PLC-26W/830	120v	26w	3000K	1800	1550	82	6-1/2"	G24Q-3	1/12
PLC-26W/835	120v	26w	3500K	1800	1550	82	6-1/2"	G24Q-3	1/12
PLC-26W/841	120v	26w	4100K	1800	1550	82	6-1/2"	G24Q-3	1/12

\*Major Brand

LAMPS – COMPACT FLUORESCENT LAMPS – PL-L LONG FLUORESCENT LAMPS\*

Burning Position: Any

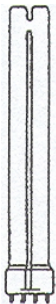

MODEL	VOLT	WATT	COLOR TEMP	INITIAL LUMENS	DESIGN LUMENS	CRI	MOL	BASE	INNER PK/ MASTER CTN
<b>Average Life: 12,000 Hours</b>									
PLL-18W/830	120v	18w	3000K	1250	1125	82	9"	2G11	1/12
PLL-18W/835	120v	18w	3500K	1250	1125	82	9"	2G11	1/12
PLL-18W/841	120v	18w	4100K	1250	1125	82	9"	2G11	1/12
<b>Average Life: 20,000 Hours</b>									
PLL-40W/830	120v	40w	3000K	3300	2970	82	22-1/2"	2G11	1/12
PLL-40W/835	120v	40w	3500K	3300	2970	82	22-1/2"	2G11	1/12
PLL-40W/841	120v	40w	4100K	3300	2970	82	22-1/2"	2G11	1/12
<b>Average Life: 14,000 Hours</b>									
PLL-55W/830	120v	55w	3000K	4800	4470	82	22-1/2"	2G11	1/12
PLL-55W/835	120v	55w	3500K	4800	4470	82	22-1/2"	2G11	1/12
PLL-55W/841	120v	55w	4100K	4800	4470	82	22-1/2"	2G11	1/12

\*Major Brand

LAMPS – COMPACT FLUORESCENT LAMPS – PL-T TRIPLE 4-PIN FLUORESCENT LAMPS\*

Average Life: 12,000 Hours

Burning Position: Any

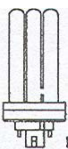









MODEL	VOLT	WATT	COLOR TEMP	INITIAL LUMENS	DESIGN LUMENS	CRI	MOL	BASE	INNER PK/ MASTER CTN
PLT-18W/830	120v	18w	3000K	1200	1020	82	4-5/8"	GX24Q	1/12
PLT-18W/835	120v	18w	3500K	1200	1020	82	4-5/8"	GX24Q	1/12
PLT-18W/841	120v	18w	4100K	1200	1020	82	4-5/8"	GX24Q	1/12
PLT-26W/830	120v	26w	3000K	1800	1530	82	5"	GX24Q	1/12
PLT-26W/835	120v	26w	3500K	1800	1530	82	5"	GX24Q	1/12
PLT-26W/841	120v	26w	4100K	1800	1530	82	5"	GX24Q	1/12
PLT-32W/830	120v	32w	3000K	2400	2040	82	5-5/8"	GX24Q	1/12
PLT-32W/835	120v	32w	3500K	2400	2040	82	5-5/8"	GX24Q	1/12
PLT-32W/841	120v	32w	4100K	2400	2040	82	5-5/8"	GX24Q	1/12
PLT-42W/830	120v	42w	3000K	3200	2720	82	6-3/8"	GX24Q	1/12
PLT-42W/835	120v	42w	3500K	3200	2720	82	6-3/8"	GX24Q	1/12
PLT-42W/841	120v	42w	4100K	3200	2720	82	6-3/8"	GX24Q	1/12

\*Major Brand

LAMPS - FLUORESCENT LAMPS - T4 LAMPS

Average Life: 20,000 Hours

Burning Position: Any

	MODEL	VOLT	WATT	COLOR TEMP	LUMENS	CRI	MOL	STD PKG PCS/WGT
	SL4-L6/30	120v	6w	3000K	480	82+	1/2"Ø x 9"	100/10lbs
	SL4-L6/41	120v	6w	4100K	480	82+	1/2"Ø x 9"	
	SL4-L6/64	120v	6w	6400K	480	82+	1/2"Ø x 9"	
	SL4-L6/RD	120v	6w	Red	480	82+	1/2"Ø x 9"	
	SL4-L6/BU	120v	6w	Blue	480	82+	1/2"Ø x 9"	
	SL4-L6/GN	120v	6w	Green	480	82+	1/2"Ø x 9"	
	SL4-L6/BK	120v	6w	Black	480	82+	1/2"Ø x 9"	
	SL4-L8/30	120v	8w	3000K	600	82+	1/2"Ø x 13-1/8"	100/13lbs
	SL4-L8/41	120v	8w	4100K	600	82+	1/2"Ø x 13-1/8"	
	SL4-L8/64	120v	8w	6400K	600	82+	1/2"Ø x 13-1/8"	
	SL4-L8/RD	120v	8w	Red	600	82+	1/2"Ø x 13-1/8"	
	SL4-L8/BU	120v	8w	Blue	600	82+	1/2"Ø x 13-1/8"	
	SL4-L8/GN	120v	8w	Green	600	82+	1/2"Ø x 13-1/8"	
	SL4-L8/BK	120v	8w	Black	600	82+	1/2"Ø x 13-1/8"	
	SL4-L12/30	120v	12w	3000K	800	82+	1/2"Ø x 17"	100/16lbs
	SL4-L12/41	120v	12w	4100K	800	82+	1/2"Ø x 17"	
	SL4-L12/64	120v	12w	6400K	800	82+	1/2"Ø x 17"	
	SL4-L12/RD	120v	12w	Red	800	82+	1/2"Ø x 17"	
	SL4-L12/BU	120v	12w	Blue	800	82+	1/2"Ø x 17"	
	SL4-L12/GN	120v	12w	Green	800	82+	1/2"Ø x 17"	
	SL4-L12/BK	120v	12w	Black	800	82+	1/2"Ø x 17"	
	SL4-L16/30	120v	16w	3000K	1000	82+	1/2"Ø x 18-3/4"	100/17lbs
	SL4-L16/41	120v	16w	4100K	1000	82+	1/2"Ø x 18-3/4"	
	SL4-L16/64	120v	16w	6400K	1000	82+	1/2"Ø x 18-3/4"	
	SL4-L16/RD	120v	16w	Red	1000	82+	1/2"Ø x 18-3/4"	
	SL4-L16/BU	120v	16w	Blue	1000	82+	1/2"Ø x 18-3/4"	
	SL4-L16/GN	120v	16w	Green	1000	82+	1/2"Ø x 18-3/4"	
	SL4-L16/BK	120v	16w	Black	1000	82+	1/2"Ø x 18-3/4"	
	SL4-L20/30	120v	20w	3000K	1350	82+	1/2"Ø x 20-1/2"	100/18lbs
	SL4-L20/41	120v	20w	4100K	1350	82+	1/2"Ø x 20-1/2"	
	SL4-L20/64	120v	20w	6400K	1350	82+	1/2"Ø x 20-1/2"	
	SL4-L20/RD	120v	20w	Red	1350	82+	1/2"Ø x 20-1/2"	
	SL4-L20/BU	120v	20w	Blue	1350	82+	1/2"Ø x 20-1/2"	
	SL4-L20/GN	120v	20w	Green	1350	82+	1/2"Ø x 20-1/2"	
	SL4-L20/BK	120v	20w	Black	1350	82+	1/2"Ø x 20-1/2"	
	SL4-L22/41	120v	22w	4100K	1850	82+	1/2"Ø x 28"	100/25lbs
	SL4-L24/30	120v	24w	3000K	2150	82+	1/2"Ø x 34"	100/29lbs
	SL4-L24/41	120v	24w	4100K	2150	82+	1/2"Ø x 34"	
	SL4-L24/64	120v	24w	6400K	2150	82+	1/2"Ø x 34"	
	SL4-L24/RD	120v	24w	Red	2150	82+	1/2"Ø x 34"	
	SL4-L24/BU	120v	24w	Blue	2150	82+	1/2"Ø x 34"	
	SL4-L24/GN	120v	24w	Green	2150	82+	1/2"Ø x 34"	
	SL4-L24/BK	120v	24w	Black	2150	82+	1/2"Ø x 34"	
	SL4-L28/30	120v	28w	3000K	2900	82+	1/2"Ø x 45-3/4"	100/40lbs
	SL4-L28/41	120v	28w	4100K	2900	82+	1/2"Ø x 45-3/4"	
	SL4-L28/64	120v	28w	6400K	2900	82+	1/2"Ø x 45-3/4"	
	SL4-L28/RD	120v	28w	Red	2900	82+	1/2"Ø x 45-3/4"	
	SL4-L28/BU	120v	28w	Blue	2900	82+	1/2"Ø x 45-3/4"	
	SL4-L28/GN	120v	28w	Green	2900	82+	1/2"Ø x 45-3/4"	
	SL4-L28/BK	120v	28w	Black	2900	82+	1/2"Ø x 45-3/4"	







Color Temperature:

- 3000K Warm White (Soft White)
- 4100K Cool White
- 6400K Daylight

LAMPS - FLUORESCENT LAMPS - T5 LAMPS

Average Life: 20,000 Hours

Burning Position: Any

	MODEL	VOLT	WATT	COLOR TEMP	LUMENS	CRI	MOL	STD PKG PCS/WGT
	SL5-L6/30	120v	6w	3000K	480	82+	5/8"Ø x 9"	100/10lbs
	SL5-L6/35	120v	6w	3500K	480	82+	5/8"Ø x 9"	
	SL5-L6/41	120v	6w	4100K	480	82+	5/8"Ø x 9"	
	SL5-L6/50	120v	6w	5000K	480	82+	5/8"Ø x 9"	
	SL5-L6/64	120v	6w	6400K	480	82+	5/8"Ø x 9"	
	SL5-L8/30	120v	8w	3000K	600	82+	5/8"Ø x 12"	100/13lbs
	SL5-L8/35	120v	8w	3500K	600	82+	5/8"Ø x 12"	
	SL5-L8/41	120v	8w	4100K	600	82+	5/8"Ø x 12"	
	SL5-L8/50	120v	8w	5000K	600	82+	5/8"Ø x 12"	
	SL5-L8/64	120v	8w	6400K	600	82+	5/8"Ø x 12"	
	SL5-L14/30	120v	14w	3000K	1350	82+	5/8"Ø x 24"	100/20lbs
	SL5-L14/35	120v	14w	3500K	1350	82+	5/8"Ø x 24"	
	SL5-L14/41	120v	14w	4100K	1350	82+	5/8"Ø x 24"	
	SL5-L14/50	120v	14w	5000K	1350	82+	5/8"Ø x 24"	
	SL5-L14/64	120v	13w	6400K	1350	82+	5/8"Ø x 24"	
	SL5-L21/30	120v	21w	3000K	2150	82+	5/8"Ø x 36"	100/30lbs
	SL5-L21/35	120v	21w	3500K	2150	82+	5/8"Ø x 36"	
	SL5-L21/41	120v	21w	4100K	2150	82+	5/8"Ø x 36"	
	SL5-L21/50	120v	21w	5000K	2150	82+	5/8"Ø x 36"	
	SL5-L21/64	120v	21w	6400K	2150	82+	5/8"Ø x 36"	
	SL5-L28/30	120v	28w	3000K	2900	82+	5/8"Ø x 48"	100/40lbs
	SL5-L28/35	120v	28w	3500K	2900	82+	5/8"Ø x 48"	
	SL5-L28/41	120v	28w	4100K	2900	82+	5/8"Ø x 48"	
	SL5-L28/50	120v	28w	5000K	2900	82+	5/8"Ø x 48"	
	SL5-L28/64	120v	28w	6400K	2900	82+	5/8"Ø x 48"	
	SL5-L35/30	120v	35w	3000K	3650	82+	5/8"Ø x 60"	100/50lbs
	SL5-L35/35	120v	35w	3500K	3650	82+	5/8"Ø x 60"	
	SL5-L35/41	120v	35w	4100K	3650	82+	5/8"Ø x 60"	
	SL5-L35/50	120v	35w	5000K	3650	82+	5/8"Ø x 60"	
	SL5-L35/64	120v	35w	6400K	3650	82+	5/8"Ø x 60"	

Color Temperature:

- 3000K: Warm White (Soft White)
- 3500K: Natural White
- 4100K: Cool White
- 5000K: Designer White
- 6400K: Daylight

## LAMPS – METAL HALIDE PAR LAMPS – PAR20\*

Average Life: 9000 Hours

Burning Position: Any

	MODEL	VOLT	WATT	COLOR TEMP	MEAN LUMENS	BEAM ANGLE	CRI	BASE	MOL	INNER PK/ MASTER CTN
	MP20SP35W830	120v	35w	3000	1600	Spot 10°	81	Med.	3-3/4"	1/12
	MP20FL35W830	120v	35w	3000	1600	Flood 30°	81	Med.	3-3/4"	1/12

\*Major Brand

## LAMPS – METAL HALIDE PAR LAMPS – PAR30L (LONG NECK)\*

Average Life: 9000 Hours

Burning Position: Any

	MODEL	VOLT	WATT	COLOR TEMP	MEAN LUMENS	BEAM ANGLE	CRI	BASE	MOL	INNER PK/ MASTER CTN
	MP30LSP35W830	120v	35w	3000	1600	Spot 10°	81	Med.	4-3/4"	1/12
	MP30FL35W830	120v	35w	3000	1760	Flood 30°	81	Med.	4-3/4"	1/12
	MP30LSP70W830	120v	70w	3000	3880	Spot 10°	82	Med.	4-3/4"	1/12
	MP30FL70W830	120v	70w	3000	3880	Flood 40°	82	Med.	4-3/4"	1/12
	MP30LSP70W942	120v	70w	4100	3880	Spot 10°	82	Med.	4-3/4"	1/12
	MP30FL70W942	120v	70w	4100	3880	Flood 40°	82	Med.	4-3/4"	1/12

\*Major Brand

## LAMPS – METAL HALIDE PAR LAMPS – PAR38\*

Average Life: 70w – 10,000 Hours; 100w – 12,500 Hours

Burning Position: Any

	MODEL	VOLT	WATT	COLOR TEMP	MEAN LUMENS	BEAM ANGLE	CRI	BASE	MOL	INNER PK/ MASTER CTN
	MP38SP70W830	120v	70w	3000	3840	Spot 15°	82	Med.	5-1/2"	1/12
	MP38FL70W830	120v	70w	3000	3840	Flood 25°	82	Med.	5-1/2"	1/12
	MP38SP70W942	120v	70w	4100	3840	Spot 15°	82	Med.	5-1/2"	1/12
	MP38FL70W942	120v	70w	4100	3840	Flood 25°	82	Med.	5-1/2"	1/12
	MP38SP100W830	120v	100w	3000	5440	Spot 15°	85	Med.	5-1/2"	1/12
	MP38FL100W830	120v	100w	3000	5440	Flood 25°	85	Med.	5-1/2"	1/12
	MP38SP100W942	120v	100w	4100	5440	Spot 15°	85	Med.	5-1/2"	1/12
	MP38FL100W942	120v	100w	4100	5440	Flood 25°	85	Med.	5-1/2"	1/12

\*Major Brand

## ES16 (GX10 BASE) METAL HALIDE LAMPS

### Features:

ES16 – The first metal halide reflector lamp to bring together high output, excellent light quality and superb energy-efficiency in one compact, highly distinctive package. Its improved discharge arc offers excellent color stability and superb color rendering.

With the choice of a GX10 base and dimensions comparable to low voltage halogen MR16, the ES16 measures only 51mm in diameter by 62.5mm in depth. ES16 is the most compact metal halide reflector lamp for general lighting. The combination of metal halide technology and compact reflector design results in a high efficient crisp light source with an excellent beam pattern. Attractive design features are the faceted reflector and the aluminum lens cover ring.

ES50-20W available. Consult factory.

	MODEL	VOLT	WATT	CURRENT	DIMENSION	LUMINOUS INTENSITY	BEAM ANGLE	COLOR TEMP	PRICE	STD PKG
	ES16-39-24	95V	39W	0.53A	62.5mm x 51mm (2.46" x 2.01")	8000cd	24°	3000K	38.00	15/Case
	ES16-39-38	95V	39W	0.53A	62.5mm x 51mm (2.46" x 2.01")	4000cd	38°	3000K	38.00	15/Case
	ES16-39-60	95V	39W	0.53A	62.5mm x 51mm (2.46" x 2.01")	2000cd	60°	3000K	38.00	15/Case

# INDEX

2K/H101	32	CF1	8	CMFX	9	JT107	1
2K/H102	32	CFH80A-109-M1	28	CMG127	4	JT108	1
2K/H103	32	CFH80A-109-M2	28	CMG138	4	JT109	1
2K/H104	32	CFH80A-113-E	28	CMG240	4	JT110	1
2K/H106	32	CFH80A-113T-E	29	CMIJ	8	JT113	1
2K/H202	32	CFH80A-118-E	28	CMJ1	8	JT114	1
2K/H203	32	CFH80A-118T-E	29	CMJ2	8	JT115	1
2K/L101	31	CFH80A-12632T-E	29	CMJ3	9	JT116	1
2K/L102	31	CFH80A-126-E	28	CMJ4	9	JT120	2
2K/L103	31	CFH80A-132T-E	29	CMLE2	8	JT122	2
2K/L104	31	CFH80A-209-M1	28	CMLE4	8	JT123	2
2K/L106	31	CFH80-209-M2	28	CMMTA10038	6	JT127	2
2K/L202	31	CFH80A-213-E	28	CMMTA3530	6	JT130	2
2K/L203	31	CFH80A-213T-E	29	CMMTA7030	6	JT132	2
50PAR20	60	CFH80A-218-E	28	CMMTA7038	6	JT138	2
75PAR30L	60	CFH80A-218T-E	29	CMMTB10038	6	JT140	2
75PAR38	60	CFH80A-22632T-E	29	CMMTB3530	6	JT143	2
90PAR38	60	CFH80A-226-E	28	CMMTB7030	6	JT147	2
AC-E26/GU10	14	CFH80A-232T-E	29	CMMTB7038	6	JT151	2
AD1	8	CFH80C-109-M1	24	CMP7	8	JT152	2
AD1H	9	CFH80C-109-M2	24	CP4	8	JT158	3
AD5	9	CFH80C-113-E	24	CP5	8	JT220	4
AHCG128-12	45	CFH80C-113T-E	25	CUP001	44	JT230	4
AHCG128-18	45	CFH80C-118-E	24	CUP002	44	JT238	4
AHCG128-24	45	CFH80C-118T-E	25	CUP003	44	JT240	3
AHCR128	45	CFH80C-12632T-E	25	DE1	8	JT330	4
AHFR128	45	CFH80C-126-E	24	ES16-39-24	64	JT338	4
ALCG123-12	45	CFH80C-209-M1	24	ES16-39-38	64	JT37	4
ALCG123-18	45	CFH80C-209-M2	24	ES16-39-60	64	JT38	4
ALCG123-24	45	CFH80C-213-E	24	FIJ	8	JT39	4
ALCG128-12	45	CFH80C-213T-E	25	FJ1	8	JT420	5
ALCG128-18	45	CFH80C-218-E	24	FJ2	8	JT430	5
ALCG128-24	45	CFH80C-218T-E	25	FJ3	9	JT607	5
ALCR111	45	CFH80C-22632T-E	25	FJ4	9	JT617	5
ALCR123	45	CFH80C-226-E	24	FX	9	JT620	5
ALCR128	45	CFV80A-113-E	27	GD8601	10	JT630	5
ALFR111	45	CFV80A-118-E	27	GD8603	10	JT650	5
ALFR123	45	CFV80A-12642-E	27	GD8606	10	JT730	5
ALFR128	45	CM100	1	GD8611	10	JT806	3
C207F	51	CM102	1	GD8613	10	JT99	4
C207H	50	CM104	1	GN212	3, 55	JTAD1	8
C208F	51	CM106	1	GN218	3, 55	JTBX218	7
C208H	50	CM107	1	GN224	3, 55	JTBX240	7
C227F	51	CM108	1	GS10S51	56	JTBX255	7
C227H	50	CM109	1	GS10S69	58	JTG127	4
C228F	51	CM110	1	GS10S70	56	JTG138	4
C228H	50	CM113	1	GS10S71	56	JTG240	4
C229F	51	CM114	1	GS10S72	56	JTMTA10038	6
C229H	50	CM115	1	GS10S81	56	JTMTA3530	6
C233F	51	CM116	1	GS20S52	56	JTMTA7030	6
C233H	50	CM120	2	GS20S53	56	JTMTA7038	6
C240F	51	CM122	2	GS20S54	56	JTMTB10038	6
C240H	50	CM123	2	GS20S59	57	JTMTB3530	6
C241F	51	CM127	2	GS20S66	56	JTMTB7030	6
C241H	50	CM130	2	GS30S03	57	JTMTB7038	6
C242F	51	CM132	2	GS30S04	57	LC1-L	9
C242H	50	CM138	2	GS30S06	57	LC1-S	9
C243F	51	CM140	2	GS30S07	57	LC3-L	9
C243H	50	CM143	2	GS30S156	58	LC3-S	9
CC-104	40	CM147	2	GS30S64	57	LE2	8
CC-106	40	CM151	2	GS30S65	57	LE4	8
CC-108	40	CM152	2	GS40S15	57	LET151	49
CC-110	40	CM158	3	GS40S16	57	LET151-24V	49
CC-112	41	CM220	4	GS40S17	57	LET301	49
CC-114	41	CM230	4	GS40S18	57	LET303	49
CC-116	41	CM238	4	GS40S57	57	LET303-24V	49
CC-118	41	CM240	3	GS40S58	57	LET75	49
CC-120	41	CM2C	8	GS50S32	58	LET75-24V	49
CC-122	41	CM330	4	GS50S33	58	LET75-277V	49
CC-124	41	CM338	4	GS50S67C	58	LT1100	52
CC-1D-AEC	42	CM37	4	GS50S67W	58	LT1102	52
CC-1S-AEA	42	CM38	4	GS50S68C	58	LT1104	52
CC-1S-AEB	42	CM39	4	GS50S68W	58	LT1106	52
CC-1S-CT	42	CM420	5	GS60S50	58	LT1107	52
CC-204	40	CM430	5	GS90S60	58	LT1108	52
CC-206	40	CM4C	8	GU10-50	59	LT1109	52
CC-208	40	CM607	5	GU10-75	59	LT1110	52
CC-210	40	CM617	5	GZ10-50	59	LT1113	52
CC-212	41	CM620	5	HRS14	30	LT1114	52
CC-214	41	CM630	5	HT1127	55	LT1115	52
CC-216	41	CM650	5	HT1138	55	LT1116	53
CC-218	41	CM6C	8	HT1240	55	LT1120	53
CC-220	41	CM730	5	HT3127	55	LT1122	53
CC-222	41	CM806	3	HT3138	55	LT1123	53
CC-224	41	CM8C	8	HT3240	55	LT1127	53
CC-2S-AEA	42	CM99	4	JC-10	59	LT1130	53
CC-2S-AEB	42	CMAD1	8	JC-20	59	LT1132	53
CC-2S-CT	42	CMAD1H	9	JC-35	59	LT1138	53
CC-DP30	43	CMAD5	9	JC-50	59	LT1140	53
CC-DP55	43	CMBX218	7	JC-75	59	LT1143	53
CC-DP75	43	CMBX240	7	JT100	1	LT1147	53
CC-ID-AED	42	CMBX255	7	JT102	1	LT1151	54
CC-WH	43	CMDE	8	JT104	1	LT1152	54
CC-WP18	43	CMFC	8	JT106	1	LT240	54

# INDEX

LT1806	54	MH60B-100-E1	21	SC-30RND	47	SP-CC24	36
LT3100	52	MH60B-100-E2	21	SC-42RND	47	SP-CC24L	36
LT3102	52	MH60B-35-E1	21	SC-54RND	47	SP-CC36	36
LT3104	52	MH60B-35-E2	21	SC-6GU	47	SP-CC36L	36
LT3106	52	MH60B-70-E1	21	SC-6REC	47	SP-CC6	36
LT3107	52	MH60B-70-E2	21	SC-6RND	47	SP-CC6L	36
LT3108	52	MH60BA-100-E1	21	SG-6	33	SP-DC	36
LT3109	52	MH60BA-100-E2	21	SG-8	33	SP-PC	36
LT3110	52	MH60BA-35-E1	21	SG-12	33	SP-PC3	36
LT3113	52	MH60BA-35-E2	21	SG-16	33	SP-PCL	36
LT3114	52	MH60BA-70-E1	21	SG-20	33	SP-PCSW	36
LT3115	52	MH60BA-70-E2	21	SG-22	33	SP-PS3	36
LT3116	53	MH60BIC-100-E1	22	SG-24	33	SP-PS6	36
LT3120	53	MH60BIC-100-E2	22	SG-28	33	TB1	9
LT3122	53	MH60BIC-35-E1	22	SG5-6	34	TM201	13, 15
LT3123	53	MH60BIC-35-E2	22	SG5-8	34	TM202	13, 15
LT3127	53	MH60BIC-70-E1	22	SG5-14	34	TM203	13, 15
LT3130	53	MH60BIC-70-E2	22	SG5-21	34	TM204	13, 15
LT3132	53	MH60R-100-E1	22	SG5-28	34	TM205	13, 15
LT3138	53	MH60R-100-E2	22	SG5-35	34	TM208	13, 15
LT3140	53	MH60R-35-E1	22	SG5CL-6	35	TM209	13, 15
LT3143	53	MH60R-35-E2	22	SG5CL-8	35	TM210	13, 15
LT3147	53	MH60R-70-E1	22	SG5CL-14	35	TM212	13, 15
LT3240	54	MH60R-70-E2	22	SG5CL-21	35	TM214	13, 15
LT3806	54	MH60RA-100-E1	22	SG5CL-28	35	TM401	11
LV100	1	MH60RA-100-E2	22	SG5CL-35	35	TM402	11
LV102	1	MH60RA-35-E1	22	SG-B	36	TM403	11
LV104	1	MH60RA-35-E2	22	SG-BM	36	TM404	11
LV106	1	MH60RA-70-E1	22	SG-CC12	36	TM405	11
LV107	1	MH60RA-70-E2	22	SG-CC12L	36	TM407	11
LV108	1	MH80A-100-E1	26	SG-CC24	36	TM408	11
LV109	1	MH80A-100-E2	26	SG-CC24L	36	TM409	11
LV110	1	MH80A-150-E1	26	SG-CC36	36	TM410	11
LV113	1	MH80A-150-E2	26	SG-CC36L	36	TM411	11
LV114	1	MH80A-35-E1	26	SG-CC6	36	TM412	11
LV115	1	MH80A-35-E2	26	SG-CC6L	36	TM414	11
LV116	1	MH80A-70-E1	26	SG-DC	36	TM426	11
LV120	2	MH80A-70-E2	26	SG-PC	36	TM428	11
LV122	2	MP20	64	SG-PCL	36	TM501	17, 20
LV123	2	MP30	64	SG-PS3	36	TM502	17, 20
LV127	2	MP38	64	SG-PS6	36	TM503	17
LV130	2	MP7	8	SK212	3, 55	TM504	17
LV132	2	MR11-20	59	SK218	3, 55	TM505	17
LV138	2	MR11-35	59	SK224	3, 55	TM507	17
LV140	2	MR16-20	59	SK236	3, 55	TM508	17, 20
LV143	2	MR16-35	59	SK248	3, 55	TM509	17, 20
LV147	2	MR16-50	59	SK1	9	TM510	17, 20
LV151	2	MR16-75	59	SK2	9	TM513	17, 20
LV152	2	MTBL30	6	SK3	9	TM514	17, 20
LV158	3	MTBL38	6	SK4	9	TM515	17
LV220	4	PCMCA	8	SK5	9	TM516	17
LV230	4	PJTCA	8	SK6	9	TM518	17
LV238	4	PK100	46	SKC	9	TM521	17
LV240	3	PK100X	46	SL4-L6	38, 62	TM529	18, 20
LV330	4	PK200	46	SL4-L8	38, 62	TM530	18, 20
LV338	4	PK200X3	46	SL4-L12	38, 62	TM881	23, 26, 27
LV37	4	PK300	46	SL4-L16	38, 62	TM890	24
LV38	4	PK300X	46	SL4-L20	38, 62	TM891	28
LV39	4	PKC	46	SL4-L22	38, 62	TR2C	8
LV4000B	12	PKC	46	SL4-L24	38, 62	TR4C	8
LV4000BA	12	PLC-13W	61	SL4-L28	38, 62	TR6C	8
LV4000IC	12	PLC-18W	61	SL5-L6	39, 63	TR8C	8
LV4000ICA	12	PLC-26W	61	SL5-L8	39, 63	XF50T	49
LV4000R	12	PLL-18W	61	SL5-L14	39, 63	XF-60	48
LV4000RA	12	PLL-40W	61	SL5-L21	39, 63	XF-60C	45, 48
LV420	5	PLL-55W	61	SL5-L28	39, 63	XF75T	49
LV430	5	PLT-18W	61	SL5-L35	39, 63	XF-80	48
LV607	5	PLT-26W	61	SM-6S	37	XF80C	45, 48
LV617	5	PLT-32W	61	SM-14D	37	XF80S	48
LV620	5	PLT-42W	61	SM-14S	37	XF100T	49
LV630	5	PLVCA	8	SM-21D	37	XF105	48
LV650	5	RH25	47	SM-21S	37	XF105C	45, 48
LV730	5	RH30	47	SM-28D	37	XF105D	48
LV806	3	RH34	47	SM-28S	37	XF150	48
LV99	4	RH35	47	SM-B	37	XF150C	45, 48
LVBX218	7	RS20	30	SM-CC12	37	XF150D	48
LVBX240	7	RS2000B	14	SM-CC24	37	XF150T	49
LVBX255	7	RS2000BA	14	SM-CC6	37	XF200T	49
LVG127	4	RS2000IC	14	SM-DC	37	XF210C	45, 48
LVG138	4	RS2000ICA	14	SM-PC	37	XF210D	48
LVG240	4	RS2000R	14	SMV	37	XF250T	49
LVMTA10038	6	RS2000RA	14	SP-6	33	XF300T	49
LVMTA3530	6	RS30	30	SP-8	33	XF500T	49
LVMTA7030	6	RS5000B	19	SP-12	33	XL20	60
LVMTA7038	6	RS5000BA	19	SP-16	33	XM111	44
LVMTB10038	6	RS5000BIC	19	SP-20	33	XM218	44
LVMTB3530	6	RS5000BICA	19	SP-24	33	XM324	44
LVMTB7030	6	RS5000R	19	SP-28	33	XM-CC6	44
LVMTB7038	6	RS5000RA	19	SP5-14	34	XM-CC12	44
LVT151	49	RS5000RIC	19	SP5-21	34		
LVT303	49	RS5000RICA	19	SP5-28	34		
MH40B-35-E1	16	RS5000S	19	SP-B	36		
MH40B-35-E2	16	RS5000SR	19	SP-BM	36		
MH40R-35-E1	16	RS80B	23	SP-CC12	36		
MH40R-35-E2	16	RSCHB	23, 25, 26, 27, 29	SP-CC12L	36		

## NOTES

## NOTES



EMAIL: [info@jescolighting.com](mailto:info@jescolighting.com)  
WEBSITE: [www.jescolighting.com](http://www.jescolighting.com)

JESCO LIGHTING IS A UL AND ETL LISTED COMPANY