

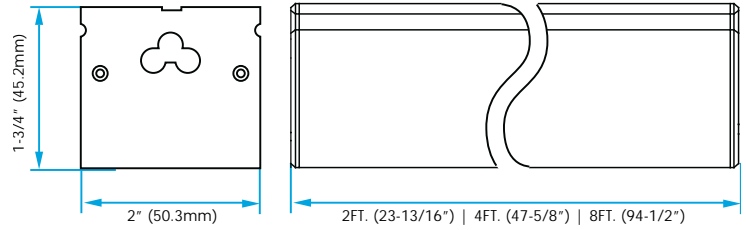

MLX
MULTI-LINX LED FIXTURE
MODULAR LINKABLE LINEAR FIXTURE

Type	
Project	
Catalog No.	

MLX
MULTI-LINX



DESCRIPTION

High performance, line voltage modular LED fixture, can be configured in wide range of arrangement to suit many lighting applications. Powder coated white housing with opal lens, can be linked in a side-by-side or a linear configuration and can deliver up to 30,000 lumens with one input. Wide selections of accessories for different mounting and side-by-side configurations. Provides continuous light and continuous runs. Available 2', 4' and 8' units, can be suspended, surface or wall mounted. Dimmable with a TRI-AC dimmer.

FEATURES

- High lumen output
- Modular installation
- Multiple mounting options and add on accessories
- Dimmable with TRI-AC dimmer

APPLICATIONS

- Aisle Lighting
- Workbench Lighting
- Warehouse Lighting
- Task Lighting
- Library Lighting
- Office Lighting
- Retail Lighting
- Supermarket Lighting
- Agricultural Lighting

SPECIFICATIONS

Input Voltage¹	120V AC
Wattage	2Ft: 18.7W 4Ft: 37.1W 8Ft: 73.8W
Max Run / Wattage	32Ft / 300W
Min Run / Wattage	2Ft / 18.7W
Beam Angle	120°
L70 Life	50,000 hours
Dimming	TRI-AC
Dimensions²	2" W x 1-3/4" H x (24", 48", 96") L
Environment	Indoor-Dry
Operating Temp.	-22°F to 120°F
Certifications	
Warranty	5 Years. See published warranty terms for detailed information.

LUMEN DATA

90CRI	MLX-24 24" 18.7 Watt		MLX-48 48" 37.1 Watt		MLX-96 96" 73.8 Watt		
CCT	Lens ⁴	Lumens	Lens ⁴	Lumens	Lens ⁴	Lumens	Efficacy
3000K	OP	1487 lm.	OP	2945 lm.	OP	5890 lm.	79 lm./W
3500K	OP	1494 lm.	OP	2958 lm.	OP	5916 lm.	80 lm./W
4000K	OP	1545 lm.	OP	3060 lm.	OP	6120 lm.	82 lm./W

80CRI ⁵	MLX-24 24" 14.1 Watt		MLX-48 48" 28.3 Watt			
CCT	Lens ⁴	Lumens	Lens ⁴	Lumens	Efficacy	
3000K	OP	1426 lm.	OP	2850 lm.	101 lm./W	

SPECIAL ORDER - Lead time applies

ORDERING INFORMATION

SERIES	LENGTH	LENS³	CCT/CRI⁵	FINISH³
MLX	24 - 2Ft 48 - 4Ft 96 - 8Ft	OP - Opal Lens ⁴	3090 - 3000K/90CRI 3590 - 3500K/90CRI 4090 - 4000K/90CRI 3080 - 3000K/80CRI ⁵	WH - White Powder Coated



EXAMPLE: **MLX-48-OP-3590-WH**

Note: For use as a grow light, contact factory to let us design the optimum LED grow light for your application. For complex systems, submit your layout for assistance. Mounting and Connecting components sold separately.

¹ Universal Voltage 120-277V AC available, contact factory.
² Nominal.
³ For clear lens or for silver and other custom finishes contact factory.
⁴ Fully diffuses LED with no hot spots.
⁵ Only 80CRI 3000K models certified for DLC, non-dimmable, contact factory.



www.jescolighting.com
 support@jescolighting.com
 Tech Support: 855.892.0029

15 Harbor Park Drive
 Port Washington, NY 11050
 Main Line: 800.527.7796
 Fax Line: 855.265.5768

219 South 6th Ave
 City of Industry, CA 91746
 Main Line: 855.654.0110
 Fax Line: 626.333.2955

JW 06/27/2018

Specifications subject to change without notice.



MLX
MULTI-LINX LED FIXTURE
MODULAR LINKABLE LINEAR FIXTURE

Type	
Project	
Catalog No.	

Lit Connectors



MLX-LC (10W)
 Lit connector joins 2 fixtures to make a 90° "L" configuration.



MLX-VC (10W)
 Lit connector joins 2 fixtures to make a 120° "V" configuration.



MLX-TC (15W)
 Lit connector joins 3 fixtures to make a "T" configuration.



MLX-YC (15W)
 Lit connector joins 3 fixtures to make a "Y" configuration.



MLX-XC (20W)
 Lit connector joins 4 fixtures to make an "X" configuration.

SERIES	SHAPE	LENS ¹	CCT/CRI	FINISH ¹
MLX				

- LC - L Lit Connector
 - VC - V Lit Connector²
 - TC - T Lit Connector
 - YC - Y Lit Connector
 - XC - X Lit Connector
- OP - Opal Lens
- 3090 - 3000K 90CRI
 - 3590 - 3500K 90CRI
 - 4090 - 4000K 90CRI
- WH - White Powder Coated

¹ For clear lens or for silver and other custom finishes, contact factory.
² NEW! Consult factory for lead time.

Input/Output Connections



MLX-PC05 5 Ft. Cable
MLX-PC10 10 Ft. Cable
 End feed cable with 3-prong plug.



MLX-PC-HW05 5 Ft. Cable
MLX-PC-HW10 10 Ft. Cable
 End feed cable for hardwiring.

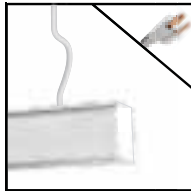

MLX-PC05-TF 5 Ft. Cable
MLX-PC10-TF 10 Ft. Cable
 Prewired top feed cable with 3-prong plug.

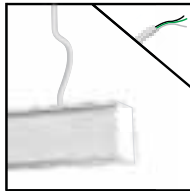

MLX-PC-HW05-TF 5 Ft. Cable
MLX-PC-HW10-TF 10 Ft. Cable
 Prewired top feed cable for hardwiring.

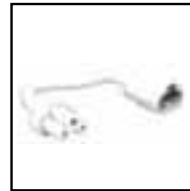

MLX-CC-06 (6 inches)
MLX-CC-12 (12 inches)
MLX-CC-18 (18 inches)
 Connecting cable with male and female connectors.



MLX-MEC
 Male endcap.



MLX-FEC
 Female endcap.



MLX-DC
 Direct power connector provides seamless connection between two fixtures.



MLX-MBCON
 Bridge connector for side-by-side configurations. Connects adjacent fixtures via female input.



MLX-FBCON
 Bridge connector for side-by-side configurations. Connects adjacent fixtures via male input.

Mounting Accessories



MLX-SCK-2 (100 inch)
 Suspension aircraft cable kit for ceiling mount. (set of 2)



MLX-MC
 Surface mounting spring clip. (set of 2)



MLX-XB-2 (2 fixtures)
MLX-XB-3 (3 fixtures)
MLX-XB-4 (4 fixtures)
MLX-XB-5 (5 fixtures)
MLX-XB-6 (6 fixtures)
 Cross bar for side-by-side configuration. Available in 2,3,4,5 and 6 fixture lengths. (set of 2)



MLX-DCS
 Direct connector support for pendant mount.

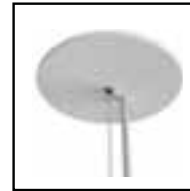

MLX-1C
 Single ceiling mount canopy.

MLX-DEC
 Single ceiling mount no feed canopy



MLX
MULTI-LINX LED FIXTURE
MODULAR LINKABLE LINEAR FIXTURE

Type	
Project	
Catalog No.	

CEILING SUSPENSION MOUNTED & LINEAR LINKED - Shown 2ft. and 4ft. fixtures connected

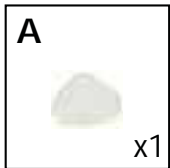
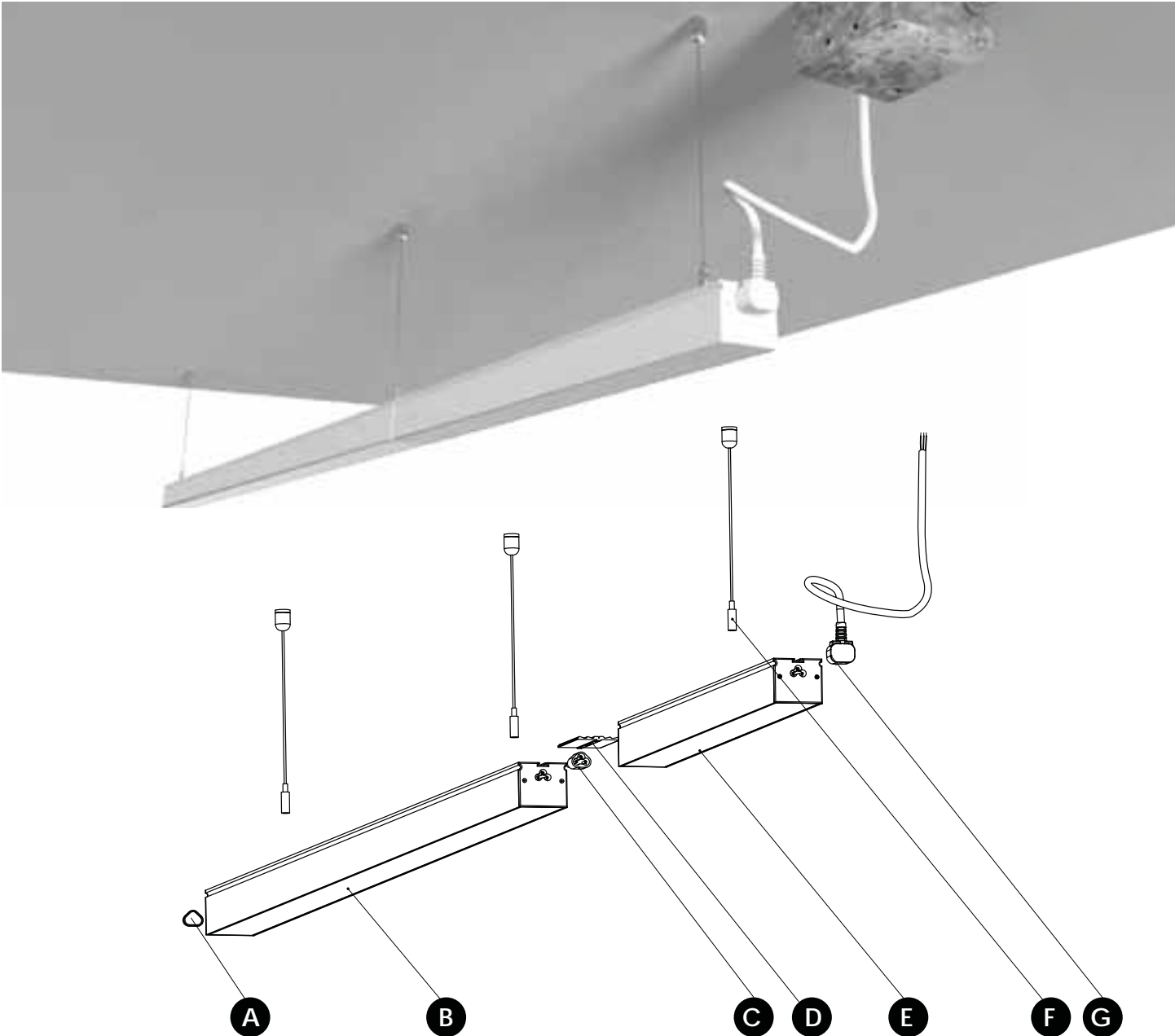

A
MLX-MEC
Male endcap.
x1

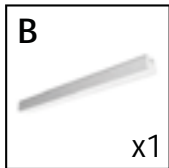

B
MLX-48
4 Ft. modular LED fixture.
x1

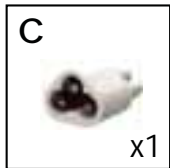

C
MLX-DC
Direct power connector provides seamless connection between two fixtures.
x1

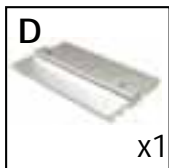

D
MLX-DCS
Direct connector support for pendant mount.
x1

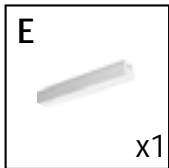

E
MLX-24
2 Ft. modular LED fixture.
x1

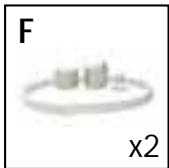

F
MLX-SCK
Suspension cable kit for ceiling mount. (set of 2)
x2

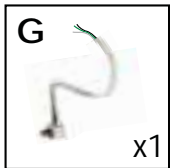

G
MLX-PC-(HW05/HW10)
End feed cable for hardwiring. see MLX-(PC05/PC10) for plug play applications.
x1



MLX

**MULTI-LINX LED FIXTURE
MODULAR LINKABLE LINEAR FIXTURE**

Type	
Project	
Catalog No.	

SURFACE MOUNT & LINEAR LINKED - shown 2ft. and 4ft. fixtures connected

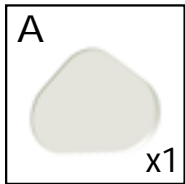
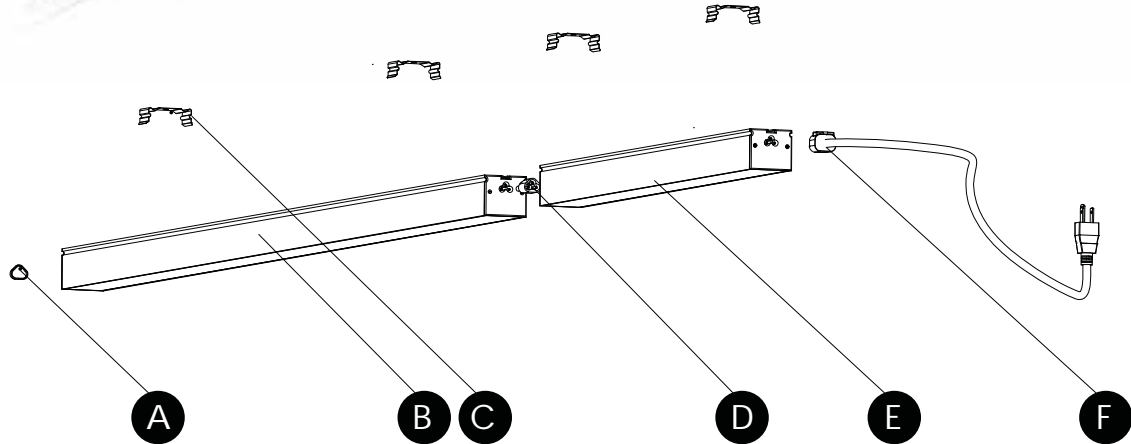

A
MLX-MEC
Male Endcap.
x1

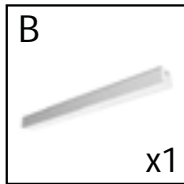

B
MLX-48
4 Ft. modular LED
fixture.
x1

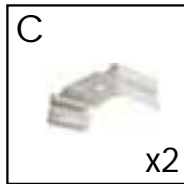

C
MLX-MC
Surface mounting
spring clip. (set of 2)
x2

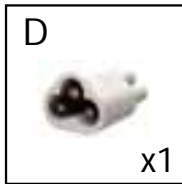

D
MLX-DC
Direct power connector
provides seamless
connection between
two fixtures.
x1

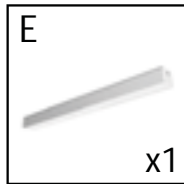

E
MLX-24
2 Ft. modular LED
fixture.
x1

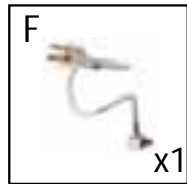

F
MLX-(PC05/PC10)
End feed cable for
hardwiring.
Use MLX-PC-(HW05/HW10)
for hardwire applications.
x1



MLX
MULTI-LINX LED FIXTURE
MODULAR LINKABLE LINEAR FIXTURE

Type	
Project	
Catalog No.	

CEILING SUSPENSION MOUNTED & SIDE STACKED - Shown 5 x 2ft. fixtures

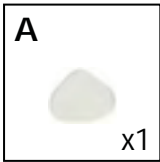
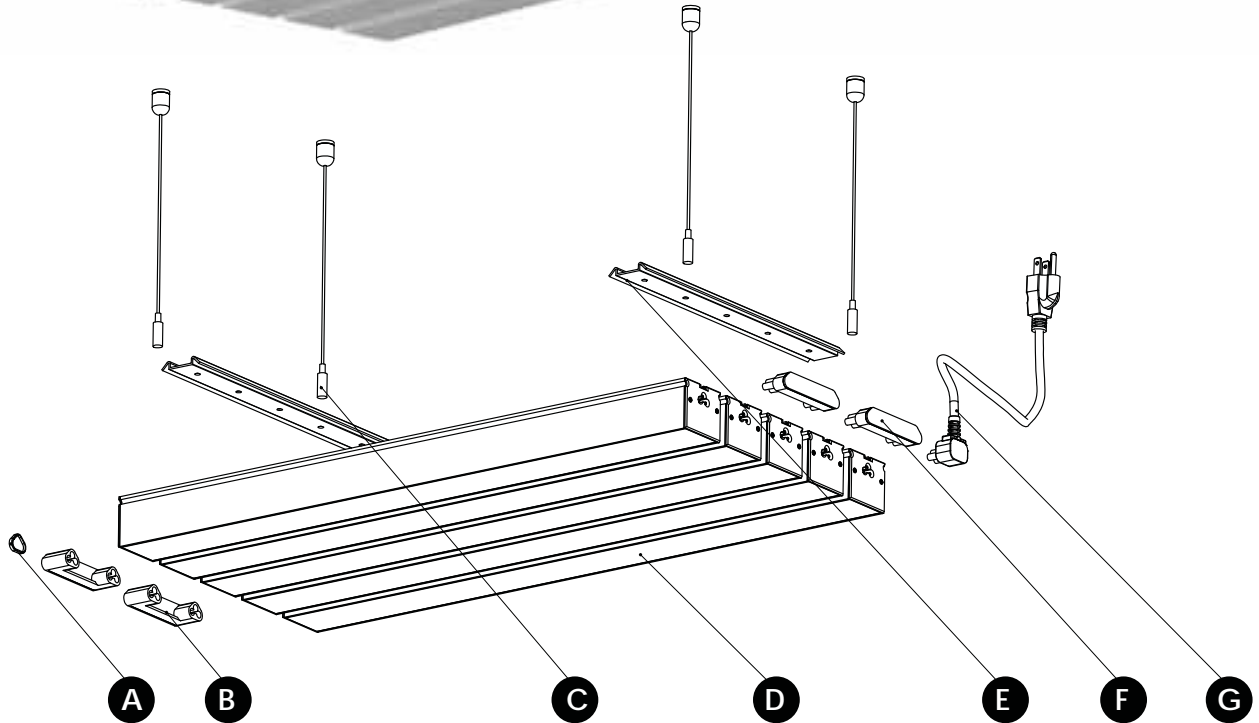
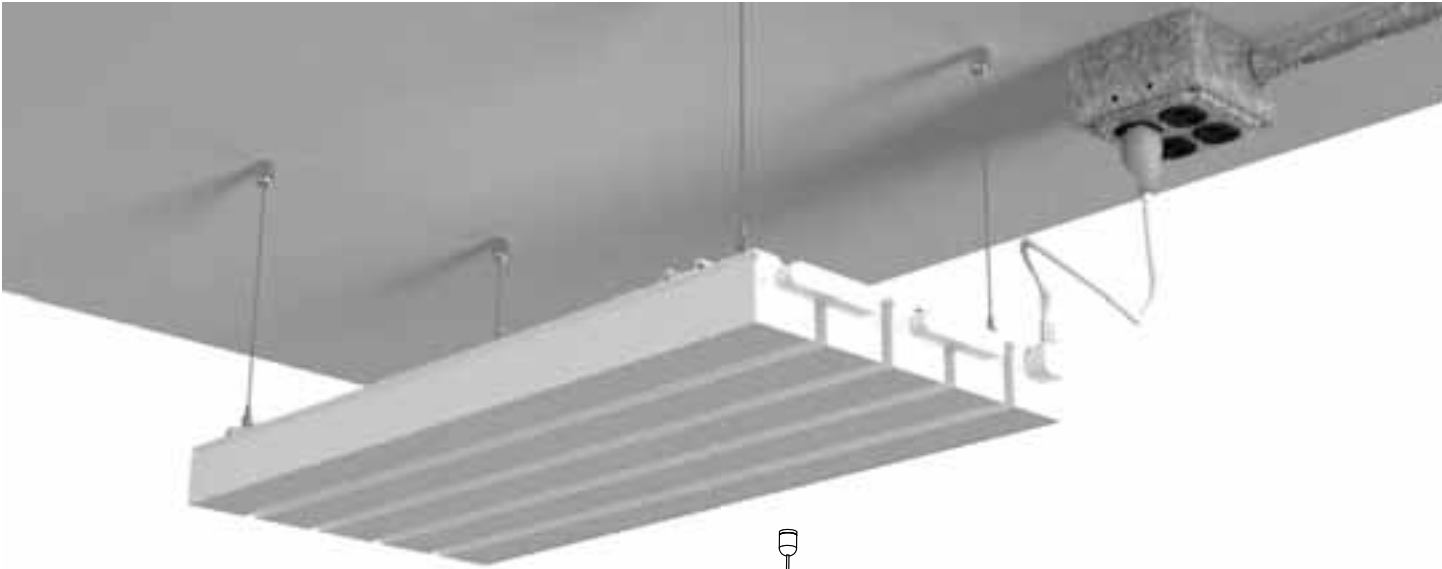

A
 MLX-MEC
 Male endcap.
 x1

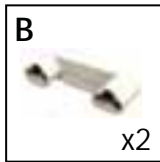

B
 MLX-MBCON
 Bridge connector for side-by-side configurations. Connects adjacent fixtures via male input.
 x2

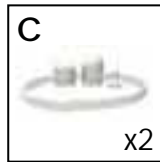

C
 MLX-SCK
 Suspension cable kit for ceiling mount. (set of 2)
 x2

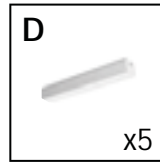

D
 MLX-24
 2 Ft. modular LED fixture.
 x5

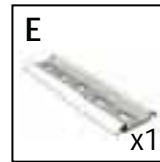

E
 MLX-XB-5
 Cross bar for side-by-side configuration. 5 fixtures cross bar used. (set of 2)
 x1

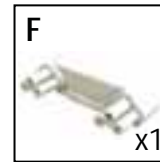

F
 MLX-FBCON
 Bridge connector for side-by-side configurations. Connects adjacent fixtures via female input.
 x1

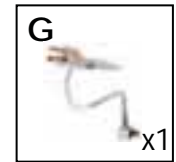

G
 MLX-(PC05/PC10)
 End feed cable with 3-prong plug. Use MLX-PC-(HW05/HW10) for hardwire applications.
 x1







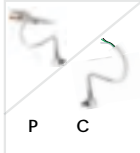

MLX
MULTI-LINX LED FIXTURE
MODULAR LINKABLE LINEAR FIXTURE

Type	
Project	
Catalog No.	

CEILING SUSPENSION MOUNTED & SIDE STACKED - critical components

Critical components needed to build side stacking fixtures with MLX. Fixtures ordered separately.
 Shipped unassembled. JESCO provides assembled fixtures ready for installation for an additional fee.

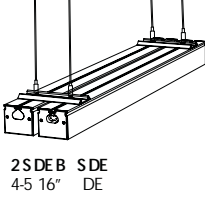
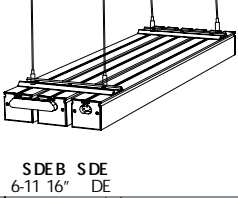
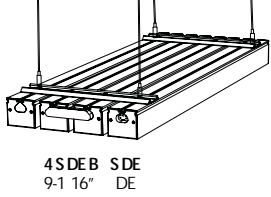
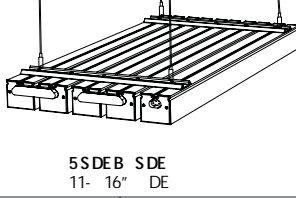
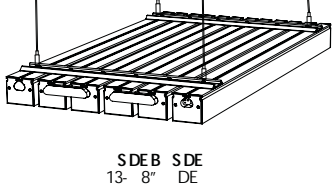
								
 <p>2SDEB SDE 4-5 16" DE</p>	quantity to order	1	1	1	—	—	1	2
	Model number	MLX-PC MLX-PC-HW	MLX-XB-2	MLX-MBCON	MLX-FBCON	MLX-MEC	MLX-FEC	MLX-SCK-2
 <p>SDEB SDE 6-11 16" DE</p>	quantity to order	1	1	1	1	1	—	2
	Model number	MLX-PC MLX-PC-HW	MLX-XB-	MLX-MBCON	MLX-FBCON	MLX-MEC	MLX-FEC	MLX-SCK-2
 <p>4SDEB SDE 9-1 16" DE</p>	quantity to order	1	1	2	1	—	1	2
	Model number	MLX-PC MLX-PC-HW	MLX-XB-4	MLX-MBCON	MLX-FBCON	MLX-MEC	MLX-FEC	MLX-SCK-2
 <p>5SDEB SDE 11- 16" DE</p>	quantity to order	1	1	2	2	1	—	2
	Model number	MLX-PC MLX-PC-HW	MLX-XB-5	MLX-MBCON	MLX-FBCON	MLX-MEC	MLX-FEC	MLX-SCK-2
 <p>SDEB SDE 13- 8" DE</p>	quantity to order	1	1		2	—	1	2
	Model number	MLX-PC MLX-PC-HW	MLX-XB-	MLX-MBCON	MLX-FBCON	MLX-MEC	MLX-FEC	MLX-SCK-2



Type	
Project	
Catalog No.	

DISTRIBUTION - POLAR PLOT 48" 3500K

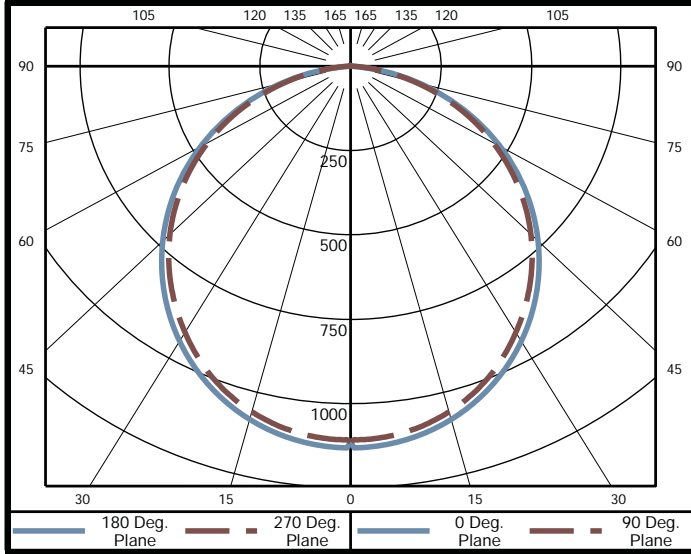

Angle	Mean CP	Lumens
0	1113	
5	1108	105
10	1092	
15	1061	300
20	1026	
25	978	450
30	921	
35	857	536
40	787	
45	712	549
50	632	
55	548	490
60	461	
65	372	368
70	281	
75	191	202
80	106	
85	36	45
90	2	

Zone	Lumens	% Luminaire
0-30	856	28.1%
0-40	1392	45.7%
0-60	2430	79.8%
0-90	3046	100.0%
40-90	1654	54.3%
60-90	616	20.2%
90-180	0	0.0%
0-180	3046	100.0%

DISTRIBUTION - CONE OF LIGHT 48" 3500K

