



CBF SERIES

COMMERCIAL BESPOKE FIXTURE
CUSTOMIZABLE SLIM LED FIXTURE

Type	
Project	
Catalog No.	



SM31

8FT MAX LENGTH



FR60 90% Light
Frosted 60° Transmittance

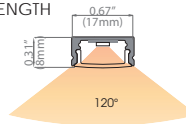

FR 80% Light
Frosted Transmittance
OP 75% Light
Opal Transmittance

SM35

6FT MAX LENGTH

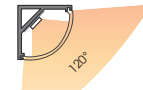

AROP 75% Light
Arc Opal Transmittance

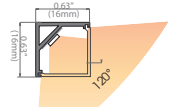

TROP 75% Light
Triangle Opal Transmittance

NOTE: SM31 channel and FR60 lens cover both available in 8ft.
FR and OP lenses available in 6ft. When an fixture over 6ft is ordered with FR or OP lens,
2 segments of FR or OP lens will be installed in the metal channel.

DESCRIPTIONS

Every CBF Bespoke fixture is tailored to your needs. CBF's SM31 and SM35 anodized aluminum channels offer a low profile design, a minimal footprint and an even light distribution. Paired with JESCO's high density LED light strip (HD72 or HD724), which features 72 LEDs per foot, the result is an ultra low profile, high light output fixture with virtually no hot spots. Other JESCO LED stripe styles available for selection also. Each CBF fixture can be customizable up to 8 feet¹ and in precise increments of 1". Multiple options of power cables and connecting cables customizable up to 8 feet length² in black and white colors².

SPECIFICATIONS

LED Strip	HD72	HD724
Input Voltage	24V DC	24V DC
Watt per Feet	6W	3.5W
Lumen per Feet ³	564lm/ft	380lm/ft
Efficacy ³	94lm/W	109lm/W
Min Run	1in.	1in.
Max Run	14ft.	20ft.

Channel	SM31			SM35	
	FR60°	FR	OP	AROP	TROP
Lens Type	FR60°	FR	OP	AROP	TROP
Beam Angle	60°	120°	120°	120°	120°
Transmittance	90%	85%	75%	75%	75%

Lumen Maintenance ⁴	50,000 hours
Dimming	TRIAC, 0-10V, PWM
Dimensions	SM31(FR60) - 11/16"W x 17/32"H x 96"L MAX SM31(FR/OP) - 11/16"W x 5/16"H x 96"L MAX SM35 (AROP/TROP) - 5/8"W x 5/8"H x 72"L MAX
Environment	Indoor - Dry
Operating Temp.*	4°F to 104°F
Warranty	5 Years. See published warranty terms for detailed information.

* Exceeding the operating temperature values may damage the LEDs by reducing the lifespan, lumen output, adversely impact color consistency, and void the warranty. It is recommended adequate airflow and heatsinking be taken into consideration in the installation and application of this product. Improper thermal management may lead to premature product failure.

¹ Only available with SM31 channel

² Not available with all cable types see ordering information on page 2.

³ Based on lumen data from 4000K

⁴ TM-21 calculation based on LM80 report

⁵ Calculated based on LED lumen data and light transmittance of lens cover

LUMEN DATA⁵ PER FEET

		SM31			SM35	
		FR60°	FR	OP	AROP	TROP
HD72	2700K	433lm	385lm	361lm	361lm	361lm
	3000K	453lm	402lm	377lm	377lm	377lm
	3500K	473lm	421lm	394lm	394lm	394lm
	4000K	508lm	451lm	423lm	423lm	423lm
	6000K	532lm	473lm	443lm	443lm	443lm

		SM31			SM35	
		FR60°	FR	OP	AROP	TROP
HD724	3000K	333lm	296lm	277lm	277lm	277lm
	3500K	342lm	304lm	285lm	285lm	285lm
	4000K	342lm	304lm	285lm	285lm	285lm
	6000K	351lm	312lm	293lm	293lm	293lm

USEFUL LINKS



Scan Me
CBF Configurator



Scan Me
Volt Loss Calculator



Scan Me
Catalog Lighting Solutions

JESCO
LIGHTING GROUP

© 2015 JESCO LIGHTING GROUP, LLC

www.jescolighting.com
support@jescolighting.com
Tech Support: 855.592.0029

15 Harbor Park Drive
Port Washington, NY 11050
Main Line: 800.527.7796
Fax Line: 855.265.5768

219 South 6th Ave
City of Industry, CA 91746
Main Line: 855.654.0110
Fax Line: 626.333.2955



Specifications subject to change without notice.

JW 11/19/2018

Page 1 of 3



CBF SERIES
COMMERCIAL BESPOKE FIXTURE
CUSTOMIZABLE SLIM LED FIXTURE

Type	
Project	
Catalog No.	

TYPICAL CONFIGURATIONS

POWER FEED from power supply or SMART TRACK output feed

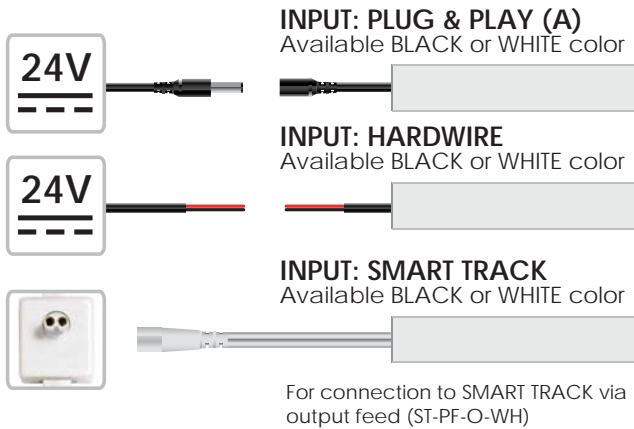

OPTIONAL CONNECTION fixture to fixture

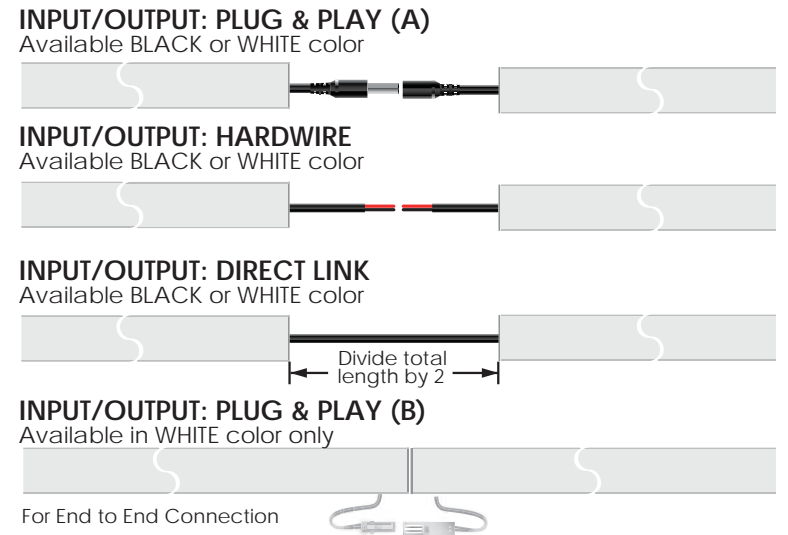

ORDERING INFORMATION

Click Here to download CBF configurator with automated filtering options. Must have Excel 2013 or newer installed.

SERIES	LENS	LENGTH	LED CCT	INPUT CABLE	LENGTH <small>based on cable selection</small>	COLOR	OUTPUT CABLE	LENGTH <small>based on cable selection</small>	COLOR
CBFSM31	FR60 - Frosted 60° FR - Frosted OP - Opal	1in up to 96in ¹	HD72- 6W/ft HD724 - 3.5W/ft	PLUG & PLAY (A).....3in up to 96in...BK or WH SMART TRACK.....3in up to 46in...BK or WH HARDWIRE.....3in up to 96in...BK or WH DIRECT LINK.....1in up to 12in...BK or WH PLUG & PLAY (B).....2in up to 18in...WH			NO OUTPUT OPTIONAL: PLUG & PLAY (A)3in up to 96in ...BK or WH HARDWIRE3in up to 96in ...BK or WH DIRECT LINK1in up to 12in ...BK or WH PLUG & PLAY (B).....2in up to 18in ...WH		

EXAMPLE: CBFSM31 FR60 84 HD7230 PLUG&PLAY(A) 72WH NO OUTPUT

SERIES	LENS	LENGTH	LED CCT	INPUT CABLE	LENGTH <small>based on cable selection</small>	COLOR	OUTPUT CABLE	LENGTH <small>based on cable selection</small>	COLOR
CBFSM35	AROP - Arc Opal TROP - Triangle Opal	1in up to 72in	HD72- 6W/ft HD724 - 3.5W/ft	PLUG & PLAY (A).....1in up to 96in...BK or WH SMART TRACK.....1in up to 46in...BK or WH HARDWIRE1in up to 96in...BK or WH DIRECT LINK.....1in up to 12in...BK or WH PLUG & PLAY (B).....1in up to 18in...WH			NO OUTPUT OPTIONAL: PLUG & PLAY (A)1in up to 96in ...BK or WH HARDWIRE1in up to 96in ...BK or WH DIRECT LINK1in up to 12in ...BK or WH PLUG & PLAY (B).....1in up to 18in ...WH		

EXAMPLE: CBFSM35 AROP 62 HD72430 PLUG&PLAY(A) NO OUTPUT



CBF SERIES

COMMERCIAL BESPOKE FIXTURE CUSTOMIZABLE SLIM LED FIXTURE

Type	
Project	
Catalog No.	

MOUNTING ACCESSORIES

SM31

CH-SM-31-CLIP
9/16" L x 13/16" W x 3/8" H
CH-SM-31 clear mounting clip

CH-SM-31-CLIP-M
9/16" L x 13/16" W x 3/8" H
CH-SM-31 metal mounting clip

CH-SM-31-CLIP-A
15/16" L x 1-13/32" W x 7/8" H
CH-SM-31 adjustable mounting clip

SM35

CH-SM-35-BR-M
3/4" L x 9/16" W x 11/16" H
CH-SM-35 metal mounting clip.

POWER SUPPLIES - See specification sheets for more information

PLUG & PLAY

UL Listed Dry Location Only

Model Number	Wattage
DL-PS-WP24/24	24W
DL-PS-24/24	24W
DL-PS-48/24	48W
DL-PS-60/24	60W
DL-PS-100/24	90W
DL-PS-100/24-CL2 ¹	96W

HARDWIRE

UL Listed Dry Location Only with junction box

Model Number	Wattage
DL-PS-20/24-JBA	20W
DL-PS-60/24-JBA	60W
DL-PS-96/24-JBA	96W

HARDWIRE DIMMABLE²

UL Listed Wet Location IP67 with junction box

Model Number	Wattage
DL-PS-40/24-JB-DIM ¹	40W
DL-PS-60/24-JB-DIM ¹	60W
DL-PS-100/24-JB-DIM ¹	96W

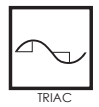

UL Listed Wet Location with junction box

Model Number	Wattage
DL-PS-80/24-JB-OD	80W
DL-PS-96/24-JB-OD	96W

UL Recognized Wet Location IP67

Model Number	Wattage
DL-PS-40/24-HW-DIM ³	40W
DL-PS-60/24-HW-DIM ³	60W
DL-PS-100/24-HW-DIM ³	96W

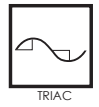

¹ UL Listed Class 2 Power Supply.
² Dimmable with TRIAC dimmer (not included), requires a minimum 8W load.
³ UL Recognized Class 2 Power Supply.

DIMMING OPTIONS

	LC-DIM5A LC-DIM5A-HW DS-DV-TV-WH	0-10V Plug & Play Dimmer 0-10V Hardwire Dimmer Wall-Plate Dimmer
	LC-DIM100-RF LC-DIM100-RF-HW LC-DIM200-RF-HW LC-RF-400H-DIM LC-RF-400W-DIM LC-RF-402W-DIM LC-RF-400-RCV	Plug & Play Remote Step Dimmer Hardwire Remote Step Dimmer Simple Hand-held Radio Frequency Dimmer Controller Hand-held Radio Frequency Dimmer Controller Wall Mounted Radio Frequency Dimmer Controller Wall Mounted Dual Radio Frequency Dimmer Controller Radio Frequency Receiver

PLUG & PLAY SWITCH

DL-PS-PIR-SW-BK
1-11/16" L x 1-9/16" W x 5/8" H
Passive Infrared Sensor Switch with 140° beam range

DL-PS-SW-(BK/WH)
Ø7/8" x H 9/16" with 7-7/8" cables
Capacitive Touch Switch with Dimming (No Memory)

JESCO
LIGHTING GROUP
© 2015 JESCO LIGHTING GROUP, LLC

www.jescolighting.com
support@jescolighting.com
Tech Support: 855.592.0029

15 Harbor Park Drive
Port Washington, NY 11050
Main Line: 800.527.7796
Fax Line: 855.265.5768

219 South 6th Ave
City of Industry, CA 91746
Main Line: 855.654.0110
Fax Line: 626.333.2955

