



DL-AC-FLEX2-JA8

INFINA® FULL SPECTRUM FLEXIBLE LINEAR
DRIVERLESS FLEXIBLE LINEAR STRIP
TITLE24 JA8 Compliant

Type	
Project	
Catalog No.	



DL-AC-FLEX2-JA8 | 21 LEDs per foot | 4 in. increments | Max run length 100 ft.

DESCRIPTION

INFINA® 2 JA8 series is the next generation of specification grade, high color accuracy flexible lighting system that incorporates JESCO's exclusive, constant current, <5% flicker, Driverless AC LED technology which operates directly off of line voltage - no additional power source required and no drivers to hide. With an increment of 4 inches to a max run length of 100 ft, the product can be dimmed with a TRIAC dimmer**. The product is mounted either in a channel or with snap-in mounting clips. INFINA® is designed for dry, damp and wet locations. The LEDs are imbedded within a flexible, optically clear thermoplastic jacket. For easy installation, JESCO offers a full complement of connectors, Runs can include as many sections and connections as required without any extra setup fees. Each run is made to order, sealed and tested prior to shipping in either our New York or Los Angeles warehouses.

FEATURES

- <5% flicker, TITLE 24 JA8 compliant
- Constant current integrated chips provide uniform intensity over the entire run without loss of output at the end of runs
- Built-in thermal protection to ensure LED's performance & longevity
- Line voltage – No power supplies to hide
- Run length of 100 feet with 4 inch increments
- 3 Step Mac Adam 1 bin LEDs for color consistency
- Multiple mounting options and accessories available

SPECIFICATIONS

Input Voltage	120V AC					
Wattage*	4W per ft.					
CRI	90+					
Color Consistency	3-Step MacAdam 1 Bin LED					
Max Run / Min Run	100 ft. / 4 in.					
Wattage per foot	4 Watt/ft.					
LEDs / foot. LEDs / 4in.	21 LEDs / ft. 7 LEDs / 4in. section					
CCT	2400K	2700K	3000K	3500K	4000K	5000K
Lumen/foot*	260 lm	270 lm	293 lm	300 lm	320 lm	320 lm
Efficacy	65	67	73	75	80	80
Power Factor	>0.9					
Beam Angle	120°					
Lumen Maintenance*	50,000 hours					
Dimming**	TRIAC, C•L					
Dimensions*	11/16" (17mm) W x 1/2" (13mm) H					
Environment	Indoor/ Outdoor▲ – dry, damp and wet					
Ambient temperature	-4°F to 104°F					
Certifications	ETLus					
Warranty	5 Years*. See published warranty terms for detailed information.					

*Nominal

** Never exceed dimmer max wattage. Effectively dim down to 1%

See page 5 for recommended dimmers.

▲ Hardwire only, see page 6 for all cautions

♦TM21 calculation based on LM80 report

ORDERING INFORMATION

AC LED LUMINAIRE

MODEL – CCT-CRI

DL-AC-FLEX2-JA8 –

2790 – 2700K 90+CRI	2490 – 2400K 90+CRI ¹
3090 – 3000K 90+CRI	4090 – 4000K 90+CRI ¹
3590 – 3500K 90+CRI	5090 – 5000K 90+CRI ¹

ENDCAP

MODEL

DL-AC-FLEX2-JA8-EC

One required at the end of each run

¹Non-stocking product, lead time applies, consult factory.

POWER FEED, CONNECTING CABLE, MOUNTING ACCESSORIES For quick reference only.

DL-AC-FLEX2-JA8 –

TERMINATIONS

- HW08** – Hardwire 8 foot cord
- HW20** – Hardwire 20 foot cord
- PC02** – Plug in 2 foot cord
- PC06** – Plug in 6 foot cord

² Plug and play cable comes with replaceable fuse.

NOTE: HARDWIRE suitable indoor/outdoor | PLUG & PLAY suitable for indoor only.

DL-AC-FLEX2-JA8-

CONNECTIONS

- CC03** – 3 inch connecting cable
- CC06** – 6 inch connecting cable
- CC12** – 12 inch connecting cable
- CC24** – 24 inch connecting cable
- CC06-O** – 6 inch output connecting cable
- CC06-I** – 6 inch input connecting cable
- DL-AC-FLEX2-CC-EXT18** – 18 inch extension cable

MOUNTING ACCESSORIES

- DL-AC-FLEX2-JA8-MC** Plastic snap-in mounting clip
- DL-AC-FLEX2-JA8-MC-HW** Plastic hardwire mounting "U" clip
- DL-AC-FLEX2-JA8-CH6P** 6ft UV stabilized white plastic snap-in channel
- DL-AC-FLEX2-JA8-CH6M18** 6ft aluminum channel 18 mm height
- DL-AC-FLEX2-JA8-CH6M18-L01** 6ft snap-on frosted lens for (-CH6M18) 1mm height
- DL-AC-FLEX2-ADJBR** Universal adjustable mounting bracket for (-CH6M18)

Custom length power feed and connecting cable available, lead time and MOQ apply, consult factory.

◆ A 5 YEAR LIMITED WARRANTY for applications that necessitate up to 16 consecutive operational hours per 24 hour period.

A 2 YEAR LIMITED WARRANTY for applications that necessitate more than 16 consecutive operational hours per 24 hour period.



JESCO
LIGHTING GROUP

© JESCO LIGHTING GROUP, LLC

www.jescolighting.com
support@jescolighting.com
Tech Support: 855.592.0029

15 Harbor Park Drive
Port Washington, NY 11050
Main Line: 800.527.7796
Fax Line: 855.265.5768

219 South 6th Ave
City of Industry, CA 91746
Main Line: 855.654.0110
Fax Line: 626.333.2955

JW

11/20/2020

Specifications subject to change without notice.

Page 1 of 7



DL-AC-FLEX2-JA8

INFINA® FULL SPECTRUM FLEXIBLE LINEAR
DRIVERLESS FLEXIBLE LINEAR STRIP
TITLE24 JA8 Compliant

Type	
Project	
Catalog No.	

TERMINATION OPTIONS (Factory sealed to DL-AC-FLEX2-FS flex linear)

HARDWIRE OPTIONS (Indoor & Outdoor*)



DL-AC-FLEX2-JA8-HW08
8 foot cord with hardwired leads
Built-in 6 Amp fuse in connector

DL-AC-FLEX2-JA8-HW20
20 foot cord with hardwired leads
Built-in 6 Amp fuse in connector

PLUG-IN OPTIONS (Indoor Use Only)



DL-AC-FLEX2-JA8-PC02
2 foot cord with power plug
Built-in 8 Amp fuse in power plug, spare fuse included

DL-AC-FLEX2-JA8-PC06
6 foot cord with power plug
Built-in 8 Amp fuse in power plug, spare fuse included

*All electrical connections must be properly secured and sealed for outdoor use.

CONNECTING CABLES (Factory sealed to DL-AC-FLEX2 flex linear)

For easy installation, JESCO offers a full complement of connectors. Runs can include as many sections and connections as required without any extra setup fees. Each run is made to order, sealed and tested prior to shipping in either our New York or Los Angeles warehouses.

For every 5 feet of connecting cable – add 1 linear foot of FLEX2 strip to calculate the overall max run.

Example: 96 feet of FLEX2 strip + 15 feet of connecting cables (+3 linear feet) = 99 feet overall length <100 feet max

DIRECT CONNECTING CABLES



DL-AC-FLEX2-JA8-FLEX-CON
1 inch flex cable

DL-AC-FLEX2-JA8-CC03
3 inch connecting cable

DL-AC-FLEX2-JA8-CC06
6 inch connecting cable

DL-AC-FLEX2-JA8-CC12
12 inch connecting cable

DL-AC-FLEX2-JA8-CC24
24 inch connecting cable

PLUG-IN CONNECTING CABLES



DL-AC-FLEX2-JA8-CC06-O
6 inch connecting cable with output connection



DL-AC-FLEX2-JA8-CC06-I
6 inch connecting cable with input connection



DL-AC-FLEX2-CC-EXT18 (optional)
18 inch extension cable for CC-06-O to CC06-I

ENDCAP Required 1 per each run



DL-AC-FLEX2-JA8-EC
Clear plastic endcap

FLEXIBLE TAPE DIRECT MOUNTING OPTIONS



DL-AC-FLEX2-JA8-MC
Plastic snap-in mounting clip



DL-AC-FLEX2-JA8-MC-HW
Hardwire mounting clip
(2 included per section for hardwire applications)

UNIVERSAL ADJUSTABLE CHANNEL BRACKET



DL-AC-FLEX2-ADJBR
Universal adjustable channel mounting bracket for (-CH6M18) channel
30° increments of adjustability
2 per channel required

MOUNTING CHANNEL



DL-AC-FLEX2-JA8-CH6P
6 foot plastic snap-in mounting channel



DL-AC-FLEX2-JA8-CH6M18
6 foot (72in)



DL-AC-FLEX2-JA8-CH6M18-L01
6 foot (72in) frosted flat lens for (-CH6M18) channel
Minimal diffusion

OUTDOOR USAGE: The aluminum channel and its anodized finish combined are impervious to most outdoor weather conditions. The plastic lens cover has a UV inhibitor molded in. While it can prevent yellowing for a period of time, long time exposure in the outdoor environment will eventually degrade the UV inhibitors, causing the lens to turn yellow and become brittle. The plastic lens cover will expand and contract due to coefficient of changes in the weather. In most extreme weather, it may crack or lose its rigidity to grab hold onto the aluminum channel. The combined usage of the aluminum channel and plastic lens can lead to undesired results, such as built up of dirt, insects, and mold. Moisture can also be trapped within the channel causing water to puddle up inside which void product's warranty.



© JESCO LIGHTING GROUP, LLC

www.jescolighting.com
support@jescolighting.com
Tech Support: 855.592.0029

15 Harbor Park Drive
Port Washington, NY 11050
Main Line: 800.527.7796
Fax Line: 855.265.5768

219 South 6th Ave
City of Industry, CA 91746
Main Line: 855.654.0110
Fax Line: 626.333.2955

JW
11/20/2020

Specifications subject to change without notice.

Page 2 of 7



DL-AC-FLEX2-JA8

INFINA® FULL SPECTRUM FLEXIBLE LINEAR
DRIVERLESS FLEXIBLE LINEAR STRIP
TITLE24 JA8 Compliant

Type	
Project	
Catalog No.	

TECHNICAL DRAWING

LED STRIP WITH POWER CONNECTOR AND ENDCAP

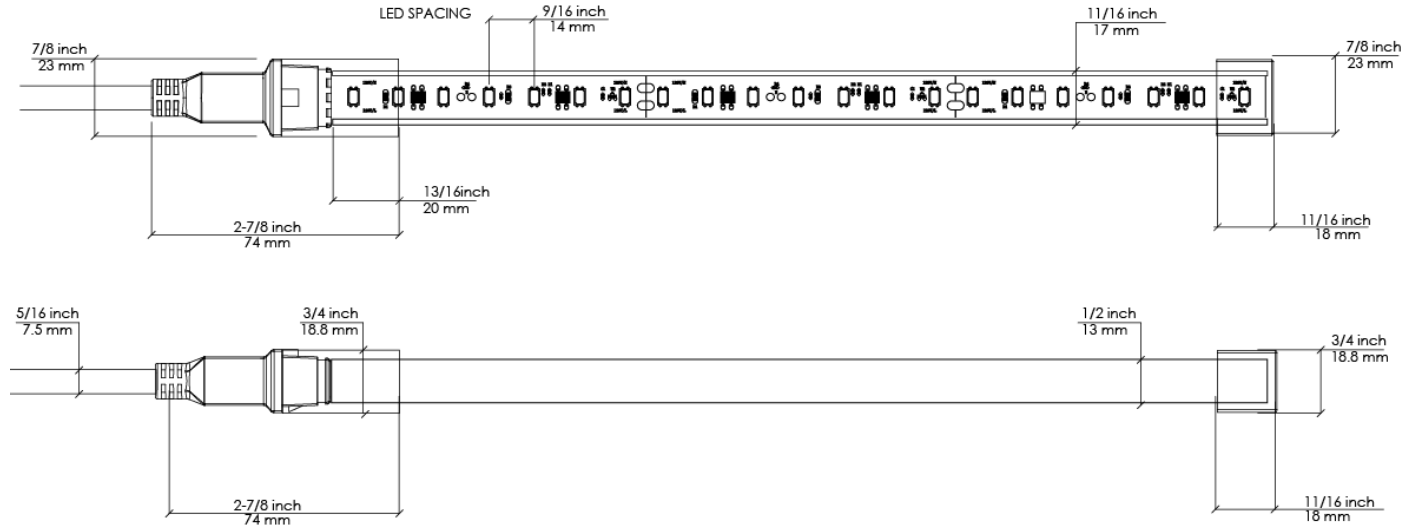

INDOOR CORD AND PLUG

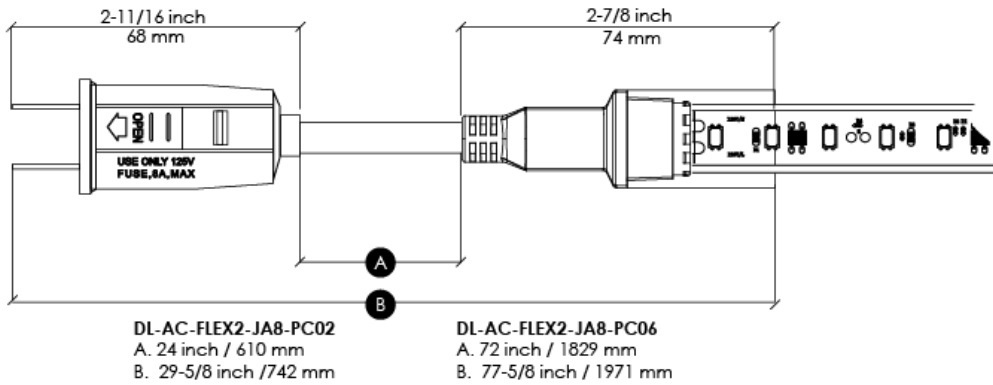

INDOOR / OUTDOOR HARDWIRE CORD (excluded strip ends)

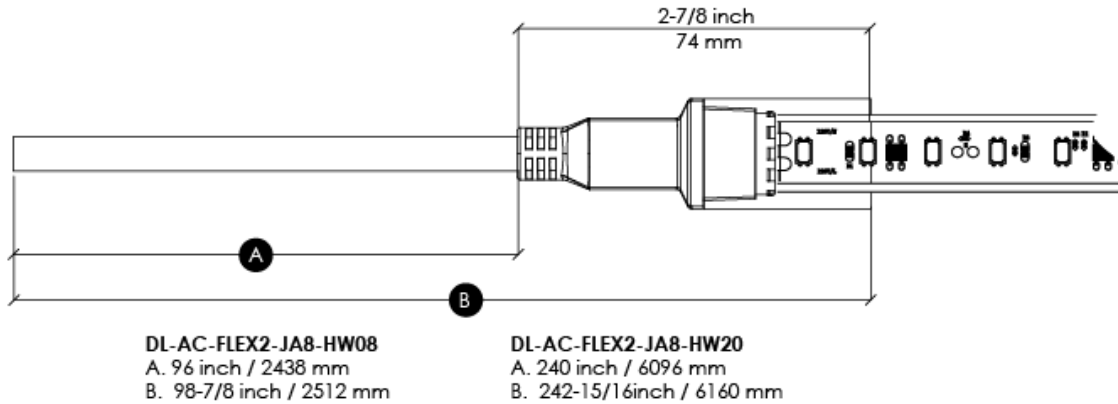

© JESCO LIGHTING GROUP, LLC

www.jescolighting.com
support@jescolighting.com
Tech Support: 855.592.0029

15 Harbor Park Drive
Port Washington, NY 11050
Main Line: 800.527.7796
Fax Line: 855.265.5768

219 South 6th Ave
City of Industry, CA 91746
Main Line: 855.654.0110
Fax Line: 626.333.2955

JW
11/20/2020

Specifications subject to change without notice.

Page 3 of 7



DL-AC-FLEX2-JA8

INFINA® FULL SPECTRUM FLEXIBLE LINEAR
DRIVERLESS FLEXIBLE LINEAR STRIP
TITLE24 JA8 Compliant

Type	
Project	
Catalog No.	

CONNECTING CABLE

Power and connecting cable rating: SJTW 300V 105°C/221°F 2x18AWG Ø 5/16inch/7.2 mm
Cable length tolerance: +3/8" (10 mm)/-0

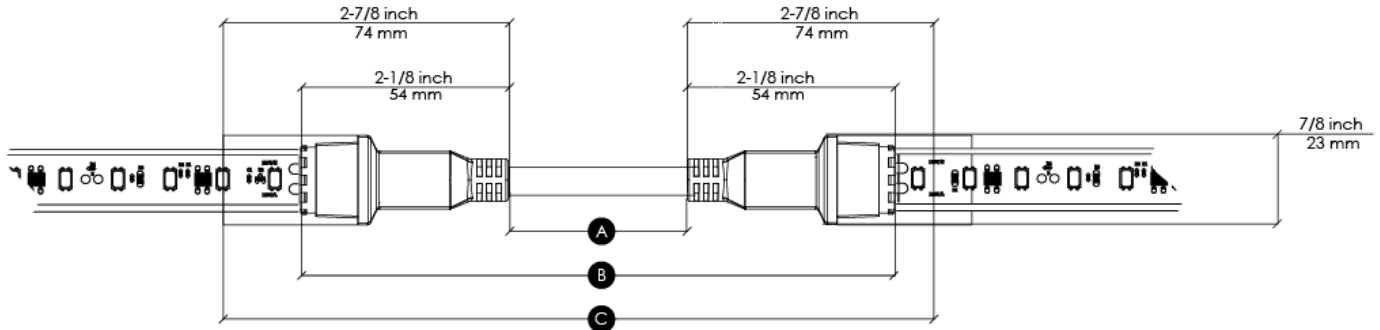

DL-AC-FLEX2-JA8-FLEX-CON A. 1 inch / 25 mm B. 5-1/4 inch / 133 mm C. 6-13/16 / 173 mm	DL-AC-FLEX2-JA8-CC03 A. 3 inch / 76 mm B. 7-1/4 inch / 184 mm C. 8-13/16 inch / 224 mm	DL-AC-FLEX2-JA8-CC06 A. 6 inch / 152 mm B. 10-1/4 inch / 260 mm C. 11-13/16 inch / 300 mm	DL-AC-FLEX2-JA8-CC12 A. 12 inch / 305 mm B. 16-1/4 inch / 413 mm C. 17-13/16 inch / 453 mm	DL-AC-FLEX2-JA8-CC24 A. 12 inch / 610 mm B. 28-1/4 inch / 718 mm C. 29-13/16 inch / 758 mm
---	--	---	--	--

CONNECTING CABLE WITH OUTDOOR RATED BARREL INPUT / OUTPUT CONNECTOR

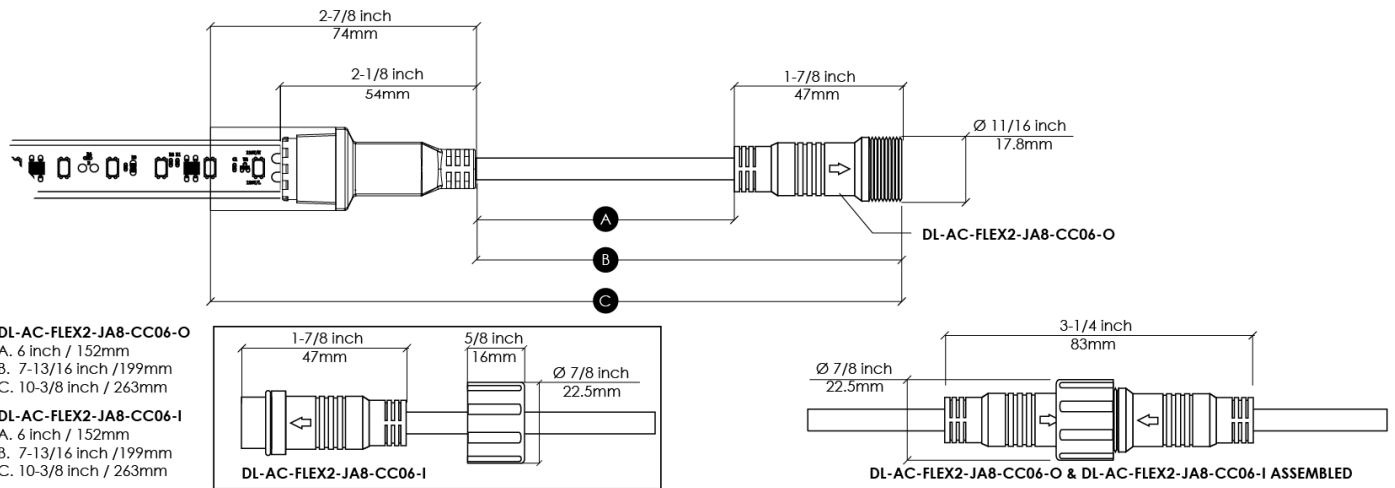

DL-AC-FLEX2-JA8-CC06-O A. 6 inch / 152mm B. 7-13/16 inch / 199mm C. 10-3/8 inch / 263mm	DL-AC-FLEX2-JA8-CC06-I A. 6 inch / 152mm B. 7-13/16 inch / 199mm C. 10-3/8 inch / 263mm
---	---

EXTENSION CABLE WITH OUTDOOR RATED BARREL INPUT / OUTPUT CONNECTOR

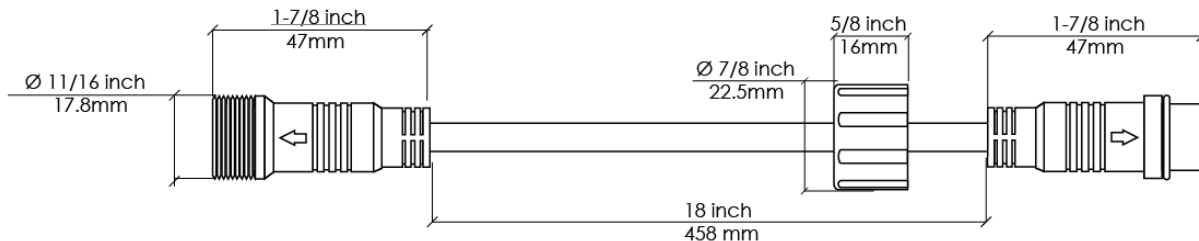

DL-AC-FLEX2-CC-EXT18



© JESCO LIGHTING GROUP, LLC

www.jescolighting.com
support@jescolighting.com
Tech Support: 855.592.0029

15 Harbor Park Drive
Port Washington, NY 11050
Main Line: 800.527.7796
Fax Line: 855.265.5768

219 South 6th Ave
City of Industry, CA 91746
Main Line: 855.654.0110
Fax Line: 626.333.2955

JW
11/20/2020

Specifications subject to change without notice.

Page 4 of 7



DL-AC-FLEX2-JA8

INFINA® FULL SPECTRUM FLEXIBLE LINEAR
DRIVERLESS FLEXIBLE LINEAR STRIP
TITLE24 JA8 Compliant

Type	
Project	
Catalog No.	

FLEXIBLE TAPE DIRECT MOUNTING CLIPS

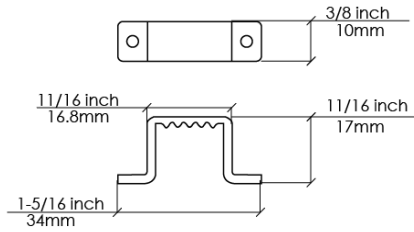

DL-AC-FLEX2-JA8-MC-HW
Hardwire clips required 2 per section

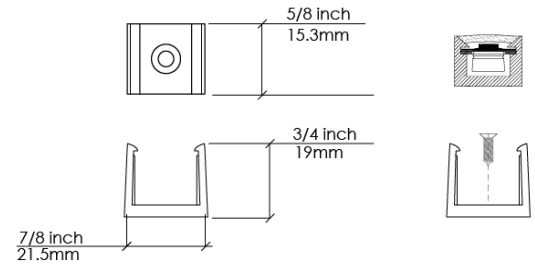
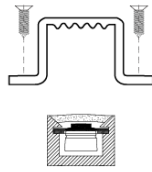

DL-AC-FLEX2-JA8-MC
Plastic Mounting Clip

MOUNTING CHANNELS

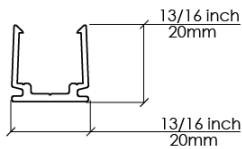

DL-AC-FLEX2-JA8-CH6P
6 Feet Plastic Channel

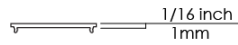

DL-AC-FLEX2-JA8-CH6M18-LC01
6 Feet Flat Frosted Lens

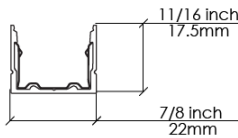

DL-AC-FLEX2-JA8-CH6M18
6 Feet Metal Channel

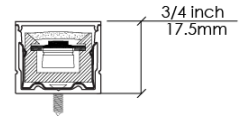
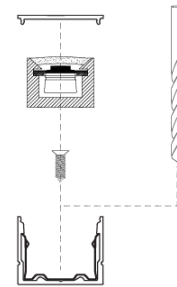

COMPATIBLE DIMMERS

MANUFACTURER	STYLE	MODEL NUMBER	MAX WATTAGE	TYPE
Lutron	Diva	DVCL-153P	600W	C•L (CFL/LED)
		DV-600P	600W	TRIAC (Incandescent/Halogen)
	Skylark	CTCL-153P	600W	C•L (CFL/LED)
		S-600P	600W	TRIAC (Incandescent/Halogen)



© JESCO LIGHTING GROUP, LLC

www.jescolighting.com
support@jescolighting.com
Tech Support: 855.592.0029

15 Harbor Park Drive
Port Washington, NY 11050
Main Line: 800.527.7796
Fax Line: 855.265.5768

219 South 6th Ave
City of Industry, CA 91746
Main Line: 855.654.0110
Fax Line: 626.333.2955

JW
11/20/2020

Specifications subject to change without notice.

Page 5 of 7



DL-AC-FLEX2-JA8

INFINA® FULL SPECTRUM FLEXIBLE LINEAR
DRIVERLESS FLEXIBLE LINEAR STRIP
TITLE24 JA8 Compliant

Type	
Project	
Catalog No.	

PHOTOMETRIC DATA

4000K PHOTOMETRIC AND TM30-15 [IES 4000K](#)

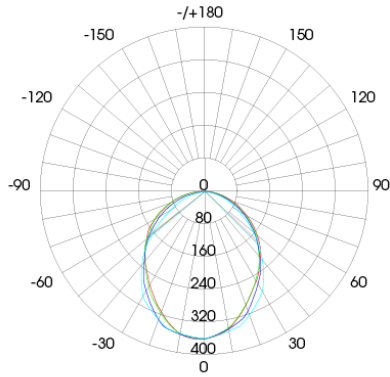

AVERAGE BEAM ANGLE(50%): 96.6 DEG

- C0/180, 98.5deg
- C30/210, 97.0deg
- C60/240, 95.7deg
- C90/270, 95.0deg

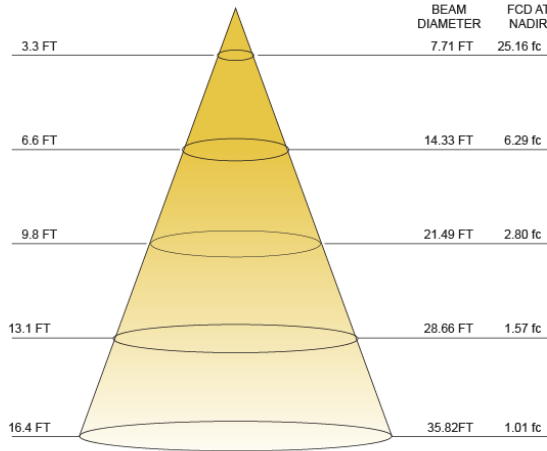

CRI (Re) (R1-R15)

R1	97	R6	95	R11	96
R2	99	R7	94	R12	73
R3	99	R8	92	R13	99
R4	95	R9	84	R14	99
R5	96	R10	98	R15	96

TM-30-15

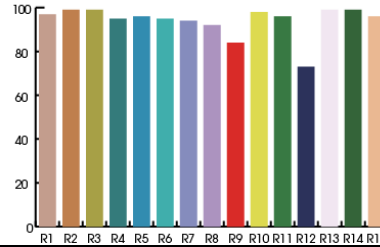
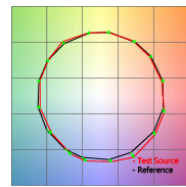

TITLE24 TEST DATA

	JA8 Requirements	DL-AC-FLEX2-JA8 Test Data 3000K
CRI	90+	95
R9 Value	≥50	83
Duv:	+/- 0.0033	-0.0003
Dimming	10%	<10%
Flicker rate Dimming 100% cut off 200Hz	<30% ≤24dBA	0.913% ≤20.9dBA
Flicker rate Dimming 20% cut off 200Hz	<30% ≤24dBA	3.74% ≤21.3dBA
Efficacy	≥45 lpw	74.36lpw
Power Factor	≥0.9	0.9488



© JESCO LIGHTING GROUP, LLC

www.jescolighting.com
support@jescolighting.com
Tech Support: 855.592.0029

15 Harbor Park Drive
Port Washington, NY 11050
Main Line: 800.527.7796
Fax Line: 855.265.5768

219 South 6th Ave
City of Industry, CA 91746
Main Line: 855.654.0110
Fax Line: 626.333.2955

JW
11/20/2020

Specifications subject to change without notice.

Page 6 of 7













DL-AC-FLEX2-JA8

INFINA® FULL SPECTRUM FLEXIBLE LINEAR
DRIVERLESS FLEXIBLE LINEAR STRIP
TITLE24 JA8 Compliant

Type	
Project	
Catalog No.	

CAUTION

 DO NOT BEND ON HORIZONTAL PLANE	 DO NOT BEND 90°	 DO NOT TWIST	 DO NOT HANG	 DO NOT SUSPEND
 DO NOT INSTALL INSIDE BUILDING STRUCTURES	 DO NOT FOLD OR OVERLAP	 DO NOT CUT LED STRIP OR CONNECTING CABLE	 DO NOT PUNCTURE LED STRIP	 DO NOT STEP ON OR PUT OBJECTS ON TOP
 DO NOT COVER	 DO NOT PAINT OVER ANY PARTS	 DO NOT USE THIRD PARTY FASTENERS	 DO NOT USE ADHESIVE FOR INSTALLATION	 DO NOT POWER ON WHEN STRIP LIGHT IS IN A SPOOL

HARDWARE WIRING

FUSE HOLDER WITH 6.3A FUSE (included)
install between the positive leads of the fixture and the power

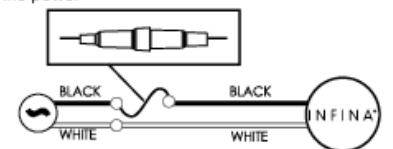

INCORRECT BRANCH CIRCUIT CONNECTION WILL VOID THE WARRANTY OF THE PRODUCT

FUSE HOLDER MUST BE INSTALLED IN THE JUNCTION BOX

HARDWARE MOUNTING



FOR HARDWARE APPLICATIONS, A PROVIDED HW CLIP MUST BE INSTALLED AT THE BEGINNING AND END OF EACH SECTION

OUTDOOR

- MAKE SURE ALL CONNECTIONS ARE SEALED AND WATER TIGHT**
- CONNECTS TO GFCI CIRCUITS ONLY
 - DO NOT SUBMERGE IN LIQUID OR IN AREAS WHERE WATER WILL PUDDLE
 - DO NOT INSTALL NEAR AREAS WITH EXPOSURE TO SALT WATER OR CHLORINATED WATER

		
--	---	---

NOTE: Avoid installing at locations with prolonged exposure to direct sunlight to prevent extended heat buildup and to prevent irreversible damages to the LED.

WARRANTY IS VOID IF ANY OF THE ABOVE ARE VIOLATED

A 5 YEAR LIMITED WARRANTY for applications that necessitate up to 16 consecutive operational hours per 24 hour period.
A 2 YEAR LIMITED WARRANTY for applications that necessitate more than 16 consecutive operational hours per 24 hour period.



www.jescolighting.com
support@jescolighting.com
Tech Support: 855.592.0029

15 Harbor Park Drive
Port Washington, NY 11050
Main Line: 800.527.7796
Fax Line: 855.265.5768

219 South 6th Ave
City of Industry, CA 91746
Main Line: 855.654.0110
Fax Line: 626.333.2955

JW
11/20/2020