



DL-FLEX2-SHD

LED FLEXIBLE LINEAR
SUPER HIGH DENSITY SERIES

Type	
Project	
Catalog No.	



DESCRIPTION

DL-FLEX2-SHD is a super high density LED tape. With 90 LEDs per foot, the DL-FLEX2-SHD is the perfect choice for designers looking for a completely smooth and uniform beam. High CRI of 90+ means excellent color rendering and a short cut length of 7/8" means high customizability. Sold by the reel or by the foot. The tape is Triac dimmable using our standard dimmable drivers or 0-10V dimmable using our LC-DIM-5A. Standard mounting with hi-bond adhesive tape. Also can be mounted using channels or mounting clips.

FEATURES

- Short cut length of 7/8"
- Super High density LEDs for a uniform beam pattern
- Low power consumption, low heat output.
- No UV/IR radiation, no mercury
- Even, 120° light distribution
- Mounts with 3M hi-bond adhesive
- Low profile and flexible (for bends 90 degrees or tighter do so at the cutting mark)
- Suitable for use in closet applications when installed with channel and lens in accordance to NEC code



APPLICATIONS

- Cove, soffit, and accent lighting
- Path, contour, and edge lighting
- Display, and back lighting
- Under-shelf and under-cabinet lighting

LUMEN DATA

Color Temp	Watts * (per ft)	Lumens (per ft)	Efficacy (lm/W)	CRI
2650-2800K	4.27W	304.9	71.4	90+
2950-3150K	4.27W	320.1	75.0	90+
3300-3600K	4.27W	329.3	77.1	90+
3800-4150K	4.27W	329.3	77.1	90+
4850-5200K	4.27W	335.4	78.5	90+
6300-6800K	4.27W	335.4	78.5	90+

SPECIFICATIONS

Beam Angle	120°
Input Voltage	24V DC
Wattage	4.27W
CRI	90+
CCT	2700K/3000K/3500K/4000K/5000K/6500K
Lamp Life	50,000 hours
Dimensions	7/16"W x 1/16"H (10mm W x 1.2mm H)
LEDs/ft	90
Operating Temperature *	-4°F to 104°F
Max Run †	20 ft
Min Run †	7/8"
Environment	Indoor-Dry
Certifications	  
Warranty	5 Years – see published warranty terms for detailed information.

* Exceeding the operating temperature values may damage the LEDs by reducing the lifespan, lumen output, adversely impact color consistency, and void the warranty. It is recommended adequate airflow and heat sinking be taken into consideration in the installation and application of this product. Improper thermal management may lead to premature product failure.

† Single runs can not exceed max run lengths. Cuts can only be made on the cutting mark.



DL-FLEX2-SHD
LED FLEXIBLE LINEAR
SUPER HIGH DENSITY SERIES

Type	
Project	
Catalog No.	

DIMENSIONS

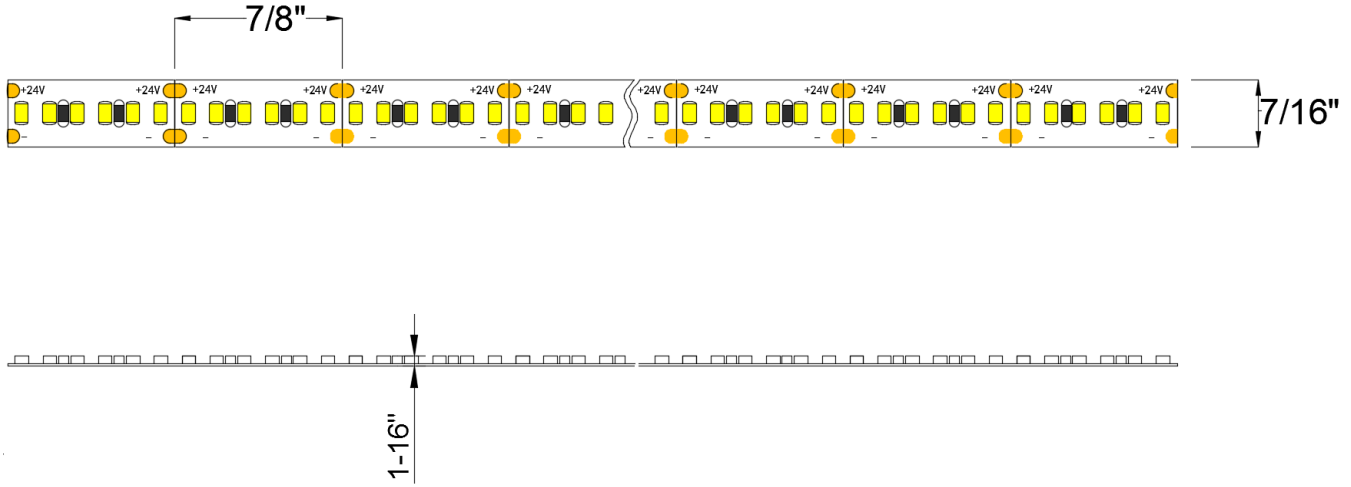

ORDERING INFORMATION

Ordered by the Foot:

SERIES	MODEL	COLOR
DL-FLEX2	SHD	
		2790 – 2650-2800K / 90CRI
		3090 – 2950-3150K / 90CRI
		3590 – 3300-3600K / 90CRI
		4090 – 3800-4150K / 90CRI
		5090 – 4850-5200K / 90CRI
		6590 – 6300-6800K / 90CRI

Specify required amount of 1 ft lengths before the ordering number.
Example: 20 x DL-FLEX2-SHD-3090

Ordered by the Reel:

SERIES	MODEL	COLOR	REEL LENGTH
DL-FLEX2	SHD		20FT
		2790 – 2650-2800K / 90CRI	
		3090 – 2950-3150K / 90CRI	
		3590 – 3300-3600K / 90CRI	
		4090 – 3800-4150K / 90CRI	
		5090 – 4850-5200K / 90CRI	
		6590 – 6300-6800K / 90CRI	

DL-FLEX2-SHD is packed in 20 ft reel lengths.
 Each reel comes with a male plug and play connector at both ends of the run.
Example: DL-FLEX2-SHD-3090-20FT



www.jescolighting.com
 support@jescolighting.com
 Tech Support: 855.592.0029

15 Harbor Park Drive
 Port Washington, NY 11050
 Main Line: 800.527.7796
 Fax Line: 855.265.5768

219 South 6th Ave
 City of Industry, CA 91746
 Main Line: 855.654.0110
 Fax Line: 626.333.2955

2/27/2020

Specifications subject to change without notice.



DL-FLEX2-SHD

LED FLEXIBLE LINEAR
SUPER HIGH DENSITY SERIES

Type	
Project	
Catalog No.	

WIRING ACCESSORIES

	DL-FLEX2-CLAMP-PC-10B Plug and play power cord. Connects plug and play equipment to DL-FLEX2. <i>Can only be connected to ends cut along the cutting mark*</i> 12" cable		DL-FLEX2-CLAMP-PC-HW-10B Hardwire power cord. Connects hard-wire equipment to DL-FLEX2. <i>Can only be connected to ends cut along the cutting mark*</i> 12" cable.
	DL-FLEX2-CLAMP-CC3-10B Connecting cable with 3" wire. Connects tape to tape. <i>Can only be connected to ends cut along the cutting mark*</i>		DL-FLEX2-CLAMP-CC6-10B Connecting cable with 6" wire. Connects tape to tape. <i>Can only be connected to ends cut along the cutting mark*</i>
	DL-FLEX2-CLAMP-CC12-10B Connecting cable with 12" wire. Connects tape to tape. <i>Can only be connected to ends cut along the cutting mark*</i>		DL-PS-PT-M 12" cable with Male barrel connector on one end and bare wires on the other. Can be used with the Individual connectors below to make Plug and play connections.

CONNECTORS

	DL-FLEX2-CLAMP-WT10B Wire to Tape Connector for 10mm wide PCB Quick Splice action, insert unstripped 22AWG wire (wire not provided) <i>Can only be connected to ends cut along the cutting mark.</i> Dims: 5/8"(14.6mm) W x 1"(24.5mm) L x 3/8"(8mm) H		DL-FLEX2-CLAMP-TT10B Tape to Tape Connector for 10mm wide PCB Connects cut ends where indicated by a cutting mark of DL-FLEX2 tape Dims: 5/8"(14.6mm) W x 7/8"(19.5mm) L x 3/8"(8mm) H
--	--	--	---

*Avoid cutting on soldered joints. Segments starting with solder joint will not work with connector.

*All dimensions are nominal

MOUNTING ACCESSORIES

	DL-FLEX2-MC-10 Mounting Clips for 10mm wide PCB
--	---



DL-FLEX2-SHD

LED FLEXIBLE LINEAR
SUPER HIGH DENSITY SERIES

Type	
Project	
Catalog No.	

POWER SUPPLIES

24V Plug and Play Power Supplies UL Listed	
Model Number	Wattage
DL-PS-WP24/24	24
DL-PS-24/24	24
DL-PS-48/24	48
DL-PS-60/24	60
DL-PS-100/24	90
DL-PS-100/24-CL2 *	96

* Class 2

24V Hard-Wire Power Supplies UL Listed	
Model Number	Wattage
DL-PS-20/24-HWA	20
DL-PS-60/24-HWA	60
DL-PS-96/24-HWA	96

24V Hard-Wire Power Supplies in Junction Box UL Listed (with Junction Box)	
Model Number	Wattage
DL-PS-20/24-JBA	20
DL-PS-60/24-JBA	60
DL-PS-96/24-JBA	96

24V Hard-Wire Outdoor Power Supplies UL Listed (with Junction Box)	
Model Number	Wattage
DL-PS-80/24-JB-OD	80
DL-PS-96/24-JB-OD	96

24V Hard-Wire Dimmable Power Supplies UL Listed	
Model Number	Wattage
DL-PS-40/24-HW-DIM*	40
DL-PS-60/24-HW-DIM*	60
DL-PS-100/24-HW-DIM*	96

*Min. 8W load required for proper dimming

24V Hard-Wire Dimmable Power Supplies in Junction Box UL Listed (with Junction Box)	
Model Number	Wattage
DL-PS-40/24-JB-DIM*	40
DL-PS-60/24-JB-DIM*	60
DL-PS-100/24-JB-DIM*	96

*Min. 8W load required for proper dimming

Lutron 24V Dimmable Power Supplies UL Listed (with Junction Box)			
Model Number		Dim Range	Wattage
DL-PS-L3DAE	Hi-lume 1% EcoSystem 24V LED Driver	100% – 1%	40
DL-PS-L3DA3W	Hi-lume 1% 3-wire 24V LED Driver	100% – 1%	40
DL-PS-LTEA2W	Hi-lume 1% 2-wire 24V LED driver (120 V forward phase only)	100% – 1%	40
DL-PS-L3D0E	Hi-lume Premier 0.1% EcoSystem 24V constant voltage LED driver with Soft-on, Fade-to-Black dimming technology	100% – 0.1%	96
DL-PS-L3D03W	Hi-lume Premier 0.1% 3-wire 24V constant voltage LED driver	100% – 0.1%	96



www.jescolighting.com
support@jescolighting.com
Tech Support: 855.592.0029

15 Harbor Park Drive
Port Washington, NY 11050
Main Line: 800.527.7796
Fax Line: 855.265.5768

219 South 6th Ave
City of Industry, CA 91746
Main Line: 855.654.0110
Fax Line: 626.333.2955

2/27/2020

Specifications subject to change without notice.



Type	
Project	
Catalog No.	

CONNECTOR APPLICATION

Our Clamp connectors can be used to make a wide variety of connections such as power cable, connecting cable and inline connections as shown below:

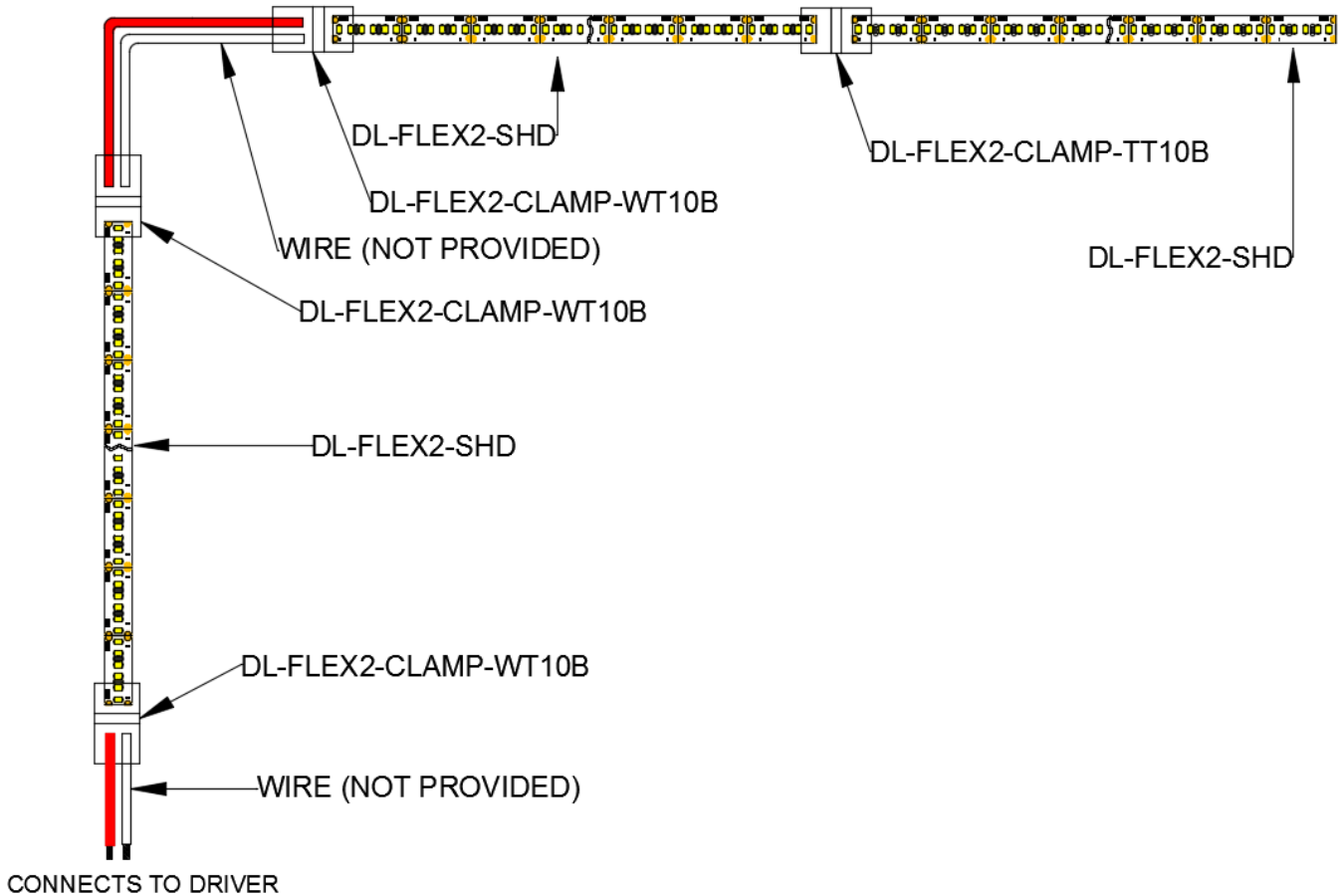

WIRING DIAGRAMS

PLUG AND PLAY

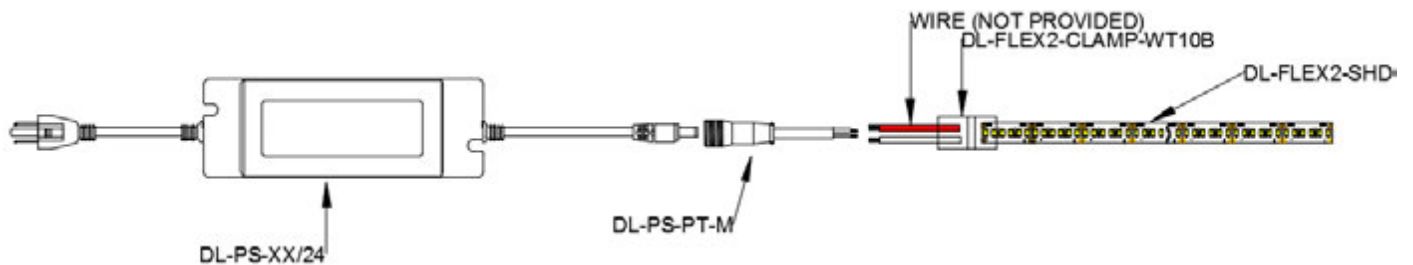



Type	
Project	
Catalog No.	

HARDWIRE

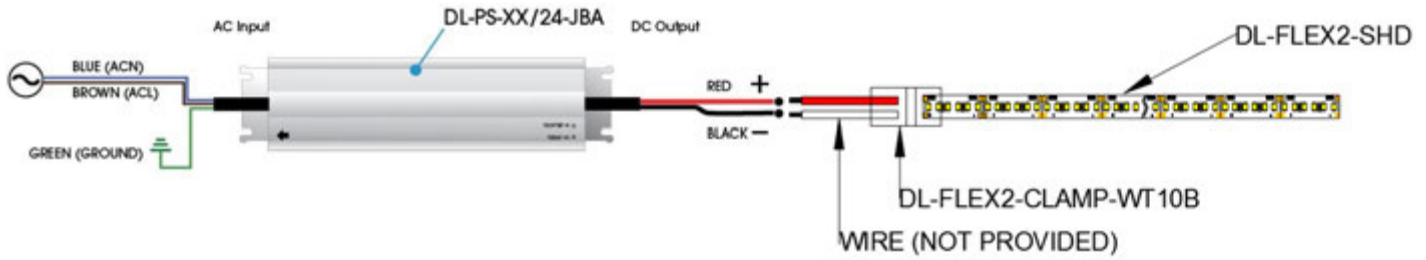

Dimming Option – TRI-AC (Using our DL-PS-XX/24-JB-DIM or DL-PS-XX/24/HW-DIM drivers). Minimum 8W load is required

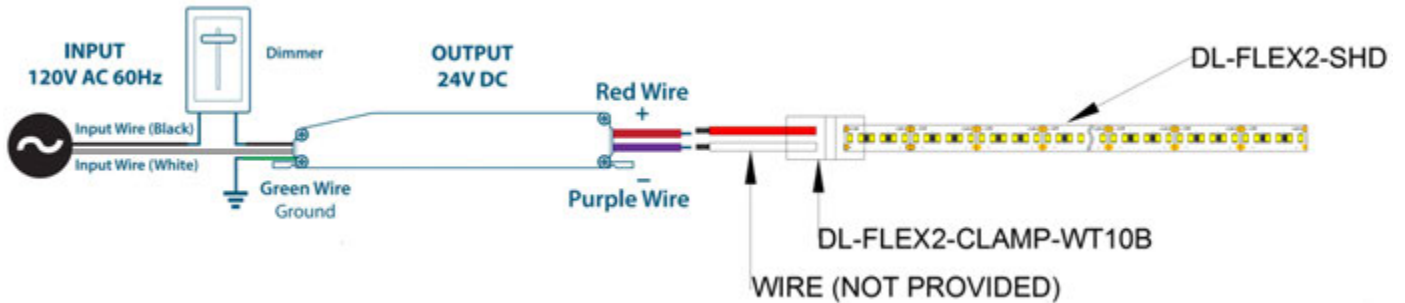

Dimming Option – 0-10V (Using our LC-DIM-5A Dimming Module)

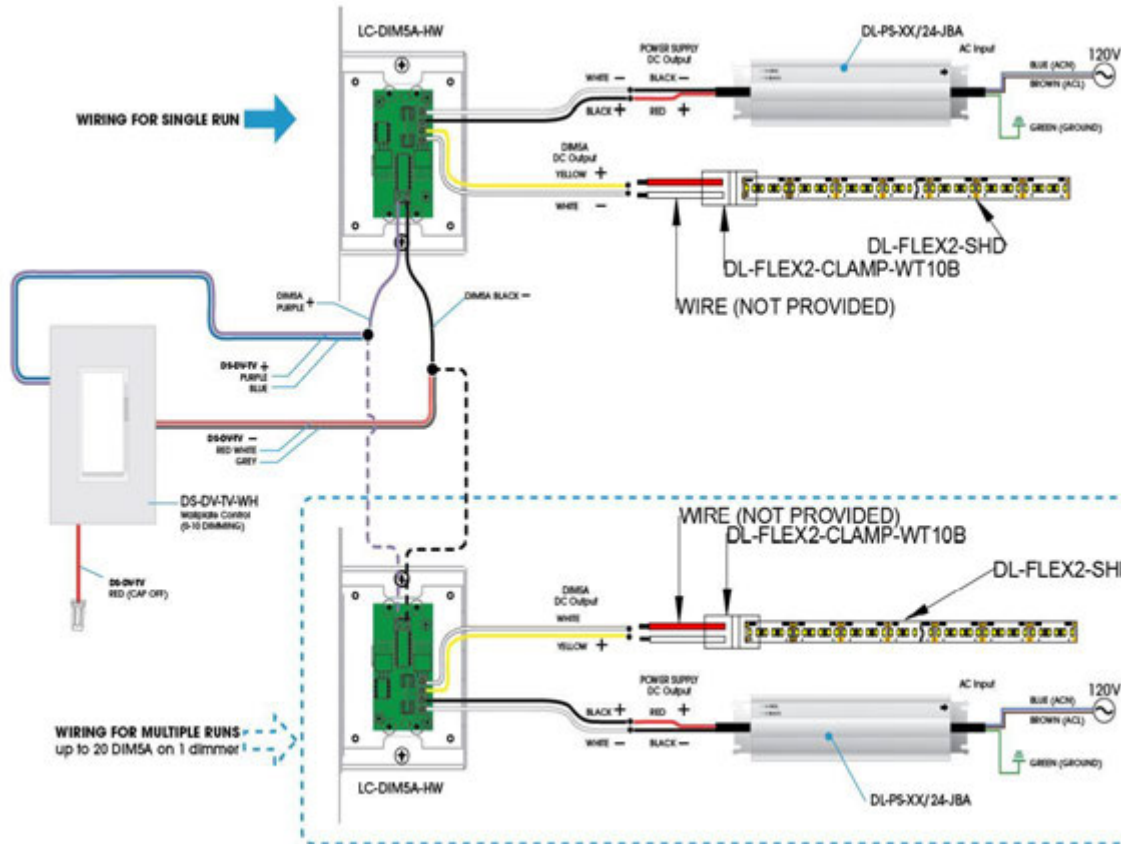



DL-FLEX2-SHD

LED FLEXIBLE LINEAR
SUPER HIGH DENSITY SERIES

Type	
Project	
Catalog No.	

DIMMING OPTIONS

DS-DV-TV-WH	Wall-Plate Dimmer
LC-DIM5A	0-10V Plug & Play Dimmer
LC-DIM5A-HW	0-10V Hardwire Dimmer
LC-DIM-01-HW	0-10V Hardwire Dimming Interface
LC-DIM100-RF	Plug & Play Remote Step Dimmer
LC-DIM100-RF-HW	Hardwire Remote Step Dimmer
LC-200-RPT	Power Repeater
LC-DIM200-RF-HW	Simple Hand-held Radio Frequency Dimmer Controller
LC-RF-400H-DIM	Hand-held Radio Frequency Dimmer Controller
LC-RF-400W-DIM	Wall Mounted Radio Frequency Dimmer Controller
LC-RF-402W-DIM	Wall Mounted Dual Radio Frequency Dimmer Controller
LC-RF-400-RCV	Radio Frequency Receiver

See our complete line of remote, wall mounted and hand-held [DIMMING OPTIONS](#) online for more information.



CHANNELS

See Channel Feature Matrix below.

See our complete line of rough-in, recessed and surface mount [FLEXIBLE LINEAR MOUNTING CHANNELS](#) online for more information.





Type	
Project	
Catalog No.	

CHANNEL FEATURE MATRIX

	ROUGH-IN				MEDIUM DEPTH PROFILE					SMALL DEPTH PROFILE					BASIC		
	CH-RI-11	CH-RI-12	CH-RI-13	CH-RI-14	CH-ME-21	CH-ME-22	CH-ME-23	CH-ME-24	CH-ME-25	CH-SM-31	CH-SM-32	CH-SM-33	CH-SM-34	CH-SM-35	DL-FLEX-CH6	DL-FLEX-CH6-B	DL-FLEX-OD-CH6
DL-FLEX2-FS	●	●	●	●	●	●	●	●	●	●	●	●	●	●		●	●
DL-FLEX2-FS w/ connectors	●	●	●	●	●	●	●	●	●	●	●	●	●	●		●	●
DL-FLEX2-SC	●	●	●	●	●	●	●	●	●	●	●	●	●	●		●	●
DL-FLEX2-SC w/ connectors	●	●	●	●	●	●	●	●	●	●	●	●	●	●		●	●
DL-FLEX2-SHD	●	●	●	●	●	●	●	●	●	●	●	●	●	●		●	●
DL-FLEX2-SHD w/ connectors	●	●	●	●	●	●	●	●	●	●	●	●	●	●		●	●
DL-FLEX2-SHO	●	●	●	●	●	●	●	●	●	●	●	●	●	●		●	●
DL-FLEX2-SHO w/ connectors	●	●	●	●	●	●	●	●	●	●	●	●	●	●		●	●
DL-FLEX2-RGB-HD	●	●	●	●	●	●	●	●	●	●	●	●	●	●		●	●
DL-FLEX2-RGB-HD w/ connectors	●	●	●	●	●	●	●	●	●	●	●	●	●	●		●	●
DL-FLEX2-RGBW	●	●	●	●						●	●	●	●	●		●	●
DL-FLEX2-RGBW w/ connectors	●	●	●	●						●	●	●	●	●		●	●
DL-FLEX2-RGBWW	●	●	●	●						●	●	●	●	●		●	●
Surface Mounting			C	C/E	D		D	D	D	D		D		D	D	D	D
45° Mounting								●						●			
Recessed – For Miter Grooves					F	G				F	G	F	G				
Rough-in – For Walls & Ceilings	A/B	A	A	A													
Adjustable Mounting										●						●	
Outdoor Mounting																	●
Flangeless			●	●	●		●	●	●	●		●		●	●	●	●
Flanged	●	●				●					●		●				
Lens Included										●	●	●	●	●			
Lensless															●	●	●
Lens – UV and Fire Rated up to 240F option	●	●	●	●	●	●	●	●	●								
Small Profile Depth – Diffused Light										●	●	●	●	●	●	●	●
Medium Profile Depth – More Diffused Light					●	●	●	●	●								
Large Profile Depth – Best Diffused Light	●	●	●	●													
Aluminum – Anodized	●	●	●	●	●	●		●	●	●	●	●	●	●	●	●	●
MDF (easy paintable)																	
6 Ft. Length										●	●	●	●	●	●	●	●
6-1/2 Ft. Length (2 meters)	●	●	●	●	●	●	●	●	●								

SUGGESTED MOUNTING TECHNIQUES

A Drywall Recessed Rough-In Mounting with Channel Housing



B Drywall Recessed Rough-In Mounting with Spring Clip



C Surface Mounting onto Drywall or Drop Ceilings



D Surface Mounting with Bracket



E Surface mounting by Sliding onto Flat Head Screws

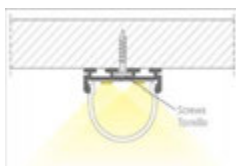

F Recessed Mounting into Mitered Groove with Bracket

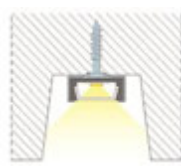

G Recessed Mounting into a Mitered Groove using a flanged Channel

