

RELYENCE DISTRIBUTOR PROGRAM



RE-GEO-FM-992XX

LED FIXTURES

4" AND 6" DISK LIGHT – J-BOX OR RETROFIT MOUNTING

Type	
Project	
Catalog No.	



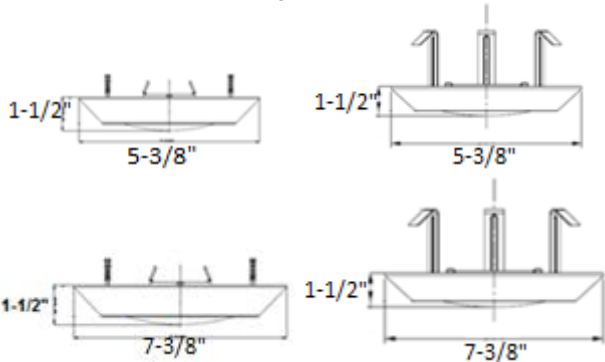

DIMENSIONS: 5-3/8" Ø x 1-1/2" H / 7-3/8" Ø x 1-1/2" H

Outlet box mounting Retrofit Mounting



SPECIFICATIONS

Model	RE-GEO-FM-992XX	
Description	Disk Light – 4" and 6"	
Input Voltage	120 VAC	
Size	4"	6"
Wattage	8W	10W
Lumens	650 lm	750 lm
Efficacy	81 lm/W	75 lm/W
CCT/CRI	2700K@90CRI	
	3000K@80CRI	
	3500K@80CRI	
Power Factor	>0.95	
Operating Temperature	-4 to +113 °F	
Dimming	Triac Dimming and CFL/LED	
Dimensions	See Diagram	
Environment	Indoor – Dry / Damp	
	  	
Warranty	5 Years – see published warranty terms for detailed information.	

▼ Exceeding the operating temperature values may damage the LEDs by reducing the lifespan, lumen output, and/or adversely impact color consistency. Improper thermal management may lead to premature product failure and void the warranty.

DESCRIPTION

JESCO's RELYENCE Series 4" and 6" LED Disk light is available in recessed configuration with a multi-groove reflector providing an easy and cost effective solution to the traditional flush mounted ceiling light. Easily mounts on to standard junction boxes or retrofits into 4" and 6" recessed housings with supplied mounting kit. These fixtures are designed for damp or dry locations and are dimmable down to 10% with Triac or CFL/LED dimmers.

FEATURES

- Up to 750 lm from 10 W
- CCT - 2700K, 3000K or 3500K ♦
- CRI >80 & 90 ♦
- Power Factor >0.95
- Dimmable down to 10% with most Triac or CFL/LED dimmers
- ADA compliant
- Beam Angle - 110°
- Damp Location Listed
- Eco-Friendly – No mercury or hazardous materials
- J-Box or retrofit mounting

♦ Refer to ordering info



www.jescolighting.com
support@jescolighting.com
Tech Support: 855.592.0029

15 Harbor Park Drive
Port Washington, NY 11050
Main Line: 800.527.7796
Fax Line: 855.265.5768

219 South 6th Ave
City of Industry, CA 91746
Main Line: 855.654.0110
Fax Line: 626.333.2955

Specifications subject to change without notice.

RELYENCE DISTRIBUTOR PROGRAM



RE-GEO-FM-992XX

LED FIXTURES

4" AND 6" DISK LIGHT – J-BOX OR RETROFIT MOUNTING

Type	
Project	
Catalog No.	

ORDERING INFORMATION

MODEL	STYLE	CCT/CRI	FINISH
RE-GEO-FM-992	04- 5-7/8" 06- 7-3/8"	2790-2700CCT/90CRI 3080-3000CCT/80CRI 3580-3500CCT/80CRI	WH-White

Example: RE-GEO-FM-99204-2790-WH

SUPPLIED WITH:

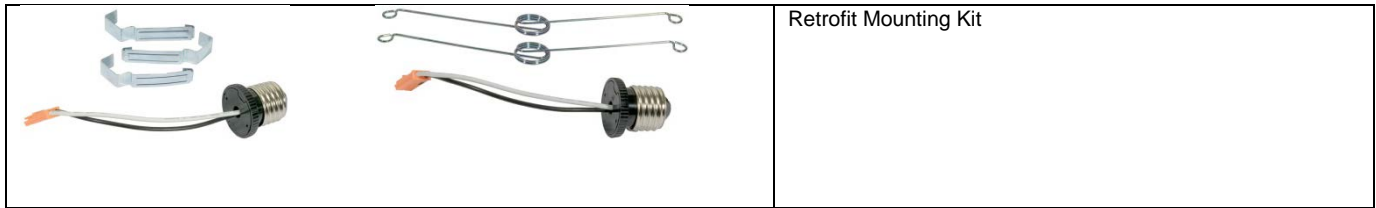

Retrofit Mounting Kit

PHOTOMETRIC DATA

LUMINOUS INTENSITY DISTRIBUTION DIAGRAM

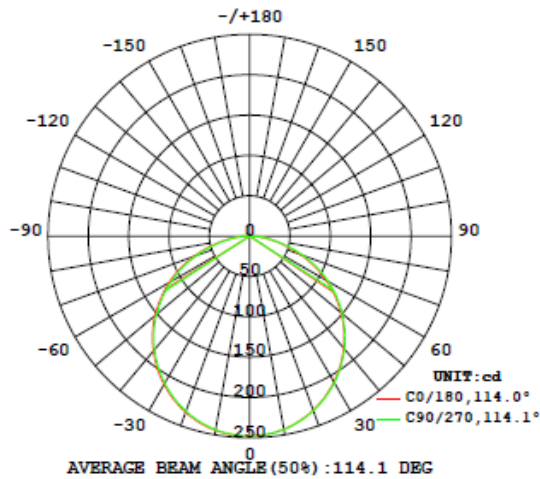

For 99204"



www.jescolighting.com
 support@jescolighting.com
 Tech Support: 855.592.0029

15 Harbor Park Drive
 Port Washington, NY 11050
 Main Line: 800.527.7796
 Fax Line: 855.265.5768

219 South 6th Ave
 City of Industry, CA 91746
 Main Line: 855.654.0110
 Fax Line: 626.333.2955

Specifications subject to change without notice.

RELYENCE DISTRIBUTOR PROGRAM



RE-GEO-FM-992XX

LED FIXTURES

4" AND 6" DISK LIGHT – J-BOX OR RETROFIT MOUNTING

Type

Project

Catalog No.

LUMINOUS INTENSITY DISTRIBUTION DIAGRAM

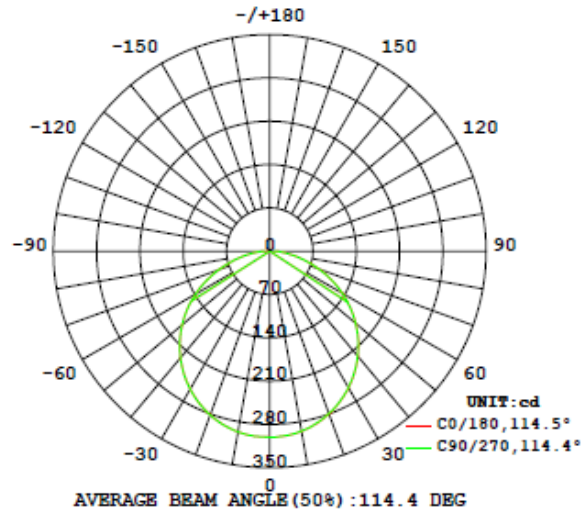

For 99206"