



RLH-P355-15

3 1/2" SQUARE (IC & NON-IC)  
PREMIER LED RECESSED DOWNLIGHTS

Type	
Project	
Catalog No.	



N- NEW CONSTRUCTION FIXTURE WITH FLAT FRAME  
(Shown with fixture and trim)



NIC- NEW CONSTRUCTION FIXTURE WITH IC RATED FRAME  
(Shown with fixture and trim)

**DESCRIPTION**

Designed for new construction applications, this 3 1/2" square commercial grade LED downlight is available in IC and Non-IC configurations. It is designed with a high lumen, COB LED, and available with three different beam angles, and three different trims – fixed, aimable beam and wallwash. The integrated high-efficacy LED, combined with the dimmable driver and high-transmission optical diffuser ensures a uniform light output.

**FEATURES**



- Trims available in All White and allow for three different lighting applications:
  - Fixed Downlight Trim** – downward directed light
  - Aimable Beam Trim** – allows for 0-30° tilt of light engine and 365° rotation with a position lock
  - Wall Washer Trim** – angle-cut, sloped reflector with molded linear spread lens for maximum uniformity
- 719.1 lumens from 15W at 3500K and 90CRI (for fixed trim)
- High Efficacy – 47.9 lm/W at 3500K and 90CRI (for fixed trim)
- Available in 2700K, 3000K, 3500K and 4000K CCTs
- Advanced heat sink provides superior thermal management for 50,000 hours of operation with 70% lumen maintenance
- Driver Power Factor >.9, THD <20%
- Dimmable (see compatibility list)
- Die cast aluminum heat sink
- Integral thermal protector to sense over-temperature or internal failure
- Junction box has (5) 1/2" knockouts with true pry-out slots and (4) knockouts with romex cable clamps
- Fixtures available in three beam angles. Reflectors can be field changeable.
- Remote Emergency Battery available\*\*
- Fits up to 1" ceiling depth

\* Exceeding the operating temperature values may damage the LEDs by reducing the lifespan, lumen output, and adversely impact color consistency. It is recommended adequate airflow and heatsinking be taken into consideration in the installation and application of this product. Improper thermal management may lead to premature product failure and void the warranty

**SPECIFICATIONS**

Model	RLH-P355
Description	Premier 3 1/2" LED Downlight
Input Voltage	120-277V AC
Wattage	15W
CCT	2700K / 3000K / 3500K / 4000K
CRI	90+
Dimmable	See compatibility list
Beam Angle	15°, 24°, 38°
Lamp Life*	50,000 hours
Power Factor	>0.9
Environment	Indoor – Dry / Damp
Ceiling Cutout	3.8" square
Certifications	 c us
Warranty	5 Years – see published warranty terms for detailed information.

**LUMEN DATA**

Color Temp	Multiplier	Lumens	Efficacy (lm/W)
2700K / 90CRI (For fixed trim)	0.935	672.4	44.8
3000K / 90CRI (For fixed trim)	0.935	672.4	44.8
3500K / 90CRI (For fixed trim)	Tested	719.1	47.9
4000K / 90CRI (For fixed trim)	1.076	773.8	51.6



**RLH-P355-15**

**3 1/2" SQUARE (IC & NON-IC)  
PREMIER LED RECESSED DOWNLIGHTS**

Type	
Project	
Catalog No.	

**FIXTURE DIMENSIONS**

PLAN VIEW

PROFILE VIEW

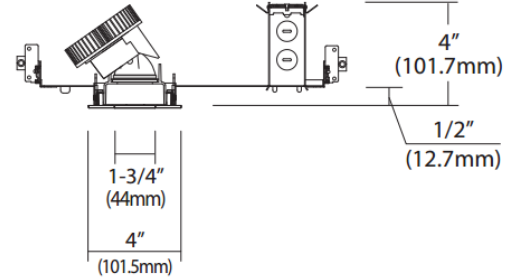
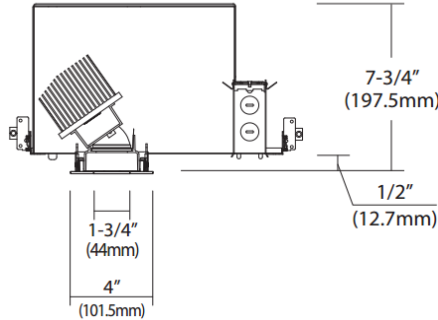
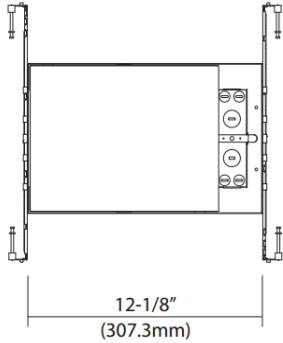

**Ceiling Cut-out : 3.8" (96.5mm)SQ.**

**ORDERING INFORMATION - 3.5" LED DOWNLIGHT – NEW CONSTRUCTION**

MODEL	SIZE	WATTAGE	MOUNTING FRAME	OPTIONAL EMERGENCY BATTERY**
RLH	P355 – 3.5" Square Premier	15 – 15W	N – Non-IC Rated Flat Frame NIC– IC Rated Flat Frame with Box	EM – Optional Emergency Battery

\*\*Consult Factory

**Note:** Reflectors and Trims specified and sold separately  
Remote Emergency Battery available, consult factory for details  
Custom finish available, consult factory for details

Example: **RLH-P355-15-N + RLET-P355FX-15-2790-N-WHWH**

**FIXED DOWNLIGHT TRIM (Specified and Sold Separately)**

Downward directed light



WHWH

**Ordering Information**

MODEL	CCT / CRI	BEAM ANGLE	FINISH
RLET-P355FX-15	2790 - 2700K / 90 CRI 3090 - 3000K / 90 CRI 3590 - 3500K / 90 CRI 4090 - 4000K / 90 CRI	N – 15° M – 24° W – 38°	WHWH – White Reflector/White Trim

\*\*Consult Factory for 80 CRI



**RLH-P355-15**

**3 1/2" SQUARE (IC & NON-IC)  
PREMIER LED RECESSED DOWNLIGHTS**

Type	
Project	
Catalog No.	

**AIMABLE BEAM TRIM (Specified and Sold Separately)**

Allows for 0-30° tilt of light engine and 365° rotation with a position lock

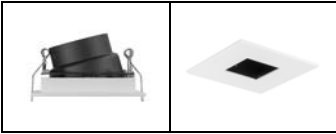

WHWH

**Ordering Information**

MODEL	CCT / CRI	BEAM ANGLE	FINISH
RLET-P355AB-15	2790 - 2700K / 90 CRI 3090 - 3000K / 90 CRI 3590 - 3500K / 90 CRI 4090 - 4000K / 90 CRI	N – 15° M – 24° W – 38°	WHWH – White Reflector/White Trim

\*\*Consult Factory for 80 CRI

**WALL WASHER TRIM (Specified and Sold separately)**

Angle-cut, sloped reflector with molded linear spread lens for maximum uniformity

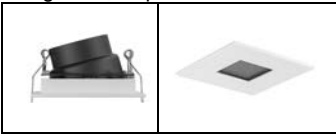

WHWH

**Ordering Information**

MODEL	CCT / CRI	BEAM ANGLE	FINISH
RLET-P355WW-15	2790 - 2700K / 90 CRI 3090 - 3000K / 90 CRI 3590 - 3500K / 90 CRI 4090 - 4000K / 90 CRI	F - Wallwash	WHWH – White Reflector/White Trim

\*\*Consult Factory for 80 CRI



**RLH-P355-15**

**3 1/2" SQUARE (IC & NON-IC)**  
**PREMIER LED RECESSED DOWNLIGHTS**

Type	
Project	
Catalog No.	

**PHOTOMETRIC DATA**

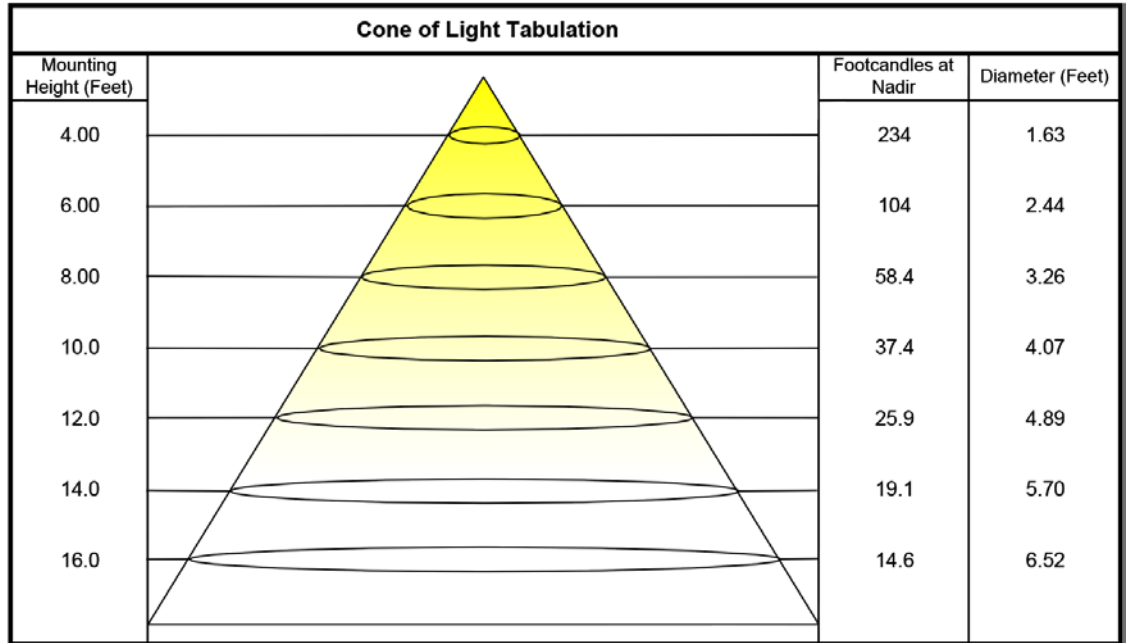

For RLET-P355FX-15-3590-M-WHWH

**COMPATIBLE DIMMERS**

MANUFACTURER	STYLE	MODEL NUMBER	TYPE
Lutron	Diva	DVCL-153P	(CFL/LED)
	Diva	DVELV-303P	(Electronic Low Voltage)
	Diva	DVTV	(0-10V)
	Diva	DV-603P	(Incandescent)
	Diva	DV-600P	(Incandescent)
	Nova	NFTV	(0-10V)
	Maestro	MAW-600	(Incandescent)
	Maestro	MAELV-600	(Electronic Low Voltage)
	Lumea	LG-600P	(Incandescent)
	Skylark	SELV-300P	(Electronic Low Voltage)
	Skylark	S-603PG	(Incandescent)
Skylark	S-600P	(Incandescent)	
	Toggler/Ariadni	TGCL-153P	(CFL/LED)
Leviton	Trimatron	6683-IW	(Incandescent)
	IllumaTech	IPI06-1LZ	(Incandescent)
	IllumaTech	IP710-DL	(0-10V)
	IllumaTech	IPE04	(Electronic Low Voltage)
	SureSlide	6631	(Incandescent)
	SureSlide	6633	(Incandescent)
	SureSlide	6673-10W	(CFL and Incandescent)
Cooper	Devine	DLC03P	(CFL/LED)
	Decorator	DAL06P	(CFL/LED)
	SKYE	SLC03P	(CFL/LED)
Lightolier		ZP260QEWE	(Electronic Low Voltage)



www.jescolighting.com  
 support@jescolighting.com  
**Tech Support:** 855.592.0029

15 Harbor Park Drive  
 Port Washington, NY 11040  
**Main Line:** 800.527.7796  
**Fax Line:** 855.265-5768

219 South 6<sup>th</sup> Ave  
 City of Industry, CA 91746  
**Main Line:** 626.333.3661  
**Fax Line:** 626.333.2955

3/9/2017

*Specifications subject to change without notice.*