



S700

SEAMLESS LED Rigid Linear

Type	
Project	
Catalog No.	



DESCRIPTION

The SEAMLESS S700 is JESCO Lighting's premier LED linear fixture. Each S700 fixture is linkable end-to-end with no dark spots even at connections between fixtures or connectors. Inter-connectable lit L-type corners provide for seamless turns - clockwise, counter-clockwise, inside-facing and outside-facing - allowing the fixture to change directions either on a horizontal or a vertical plane. Lit X- and T-type connectors are also available for a wide range of design possibilities. A uniform light output allows for intricate and complex layouts free from any break in the flow of light. Constant current IC components ensure every LED receives same specific amperage rating. This method ensures consistent levels of light output and color, no voltage drop and optimal thermal management, from the beginning to the end of the run. Mounted with integral magnets at the back of every fixture or with the snap-in mounting brackets for non-metallic surfaces (included). The fixture can also be mounted onto non-metallic surfaces with optional metal tabs (sold separately).

SPECIFICATIONS

Voltage	24V DC
CRI	90+
Ambient Operating Temperature*	-4°F to 113°F
Beam Angle	120°
Lamp Life	50,000 hours
Maximum Run	16.4 ft**
Material	Aluminum body with flat opal lens
Dimensions	7/16"W x 1/2"H
Environment	UL Listed for Damp Locations (Indoor only)***
Certifications	
Warranty	5 Years – see published warranty terms for detailed information.

* Exceeding the ambient operating temperature values may damage the LEDs by reducing the lifespan, lumen output, and adversely impact color consistency. It is recommended adequate airflow and heatsinking be taken into consideration in the installation and application of this product. Improper thermal management may lead to premature product failure and void the warranty.

** Runs may be seamlessly extended with use of S700-EXTBSF

***Must use end caps

LUMEN DATA

Part No.	Length	No. of LEDs	Watts	CCT	Lumens* (lm)	Efficacy* (lm/W)
S700	1-1/2"	7	0.40W	2700K	25.0	63
				3000K	26.4	66
				3500K	27.8	70
				4000K	27.8	70
S700	4"	21	1.25W	2700K	79.2	63
				3000K	83.6	67
				3500K	88.0	70
				4000K	88.0	70
S700	8"	42	2.50W	2700K	158.4	63
				3000K	167.2	67
				3500K	176.0	70
				4000K	176.0	70
S700	12"	63	3.70W	2700K	233.1	63
				3000K	246.1	67
				3500K	259.0	70
				4000K	259.1	70
S700	24"	126	8.00W	2700K	504.0	63
				3000K	532.0	67
				3500K	560.0	70
				4000K	560.1	70
S700	36"	189	12.00W	2700K	756.0	63
				3000K	798.0	67
				3500K	840.0	70
				4000K	840.2	70
S700	48"	252	16.00W	2700K	1008.0	63
				3000K	1064.0	67
				3500K	1120.0	70
				4000K	1120.2	70

(+/-10% tolerance)

FEATURES

- Seamless connections between fixtures
- No hot spots, even at connections between fixtures or connectors
- Long runs may be interconnected seamlessly with inline Lit Extender with bottom or side feed
- Lit inside and outside connectors in L, X and T patterns allow for lighting designs in three dimensional planes
- IC chips assure near zero light output lost from the beginning to the end of runs
- Ultra-bright 3-step MacAdam LEDs offer tight color output with a CRI >90
- Integral magnets for easy mounting
- Optional snap-in 0° or 45° mounting clips



www.jescolighting.com
support@jescolighting.com
Tech Support: 855.592.0029

15 Harbor Park Drive
Port Washington, NY 11050
Main Line: 800.527.7796
Fax Line: 855.265.5768

219 South 6th Ave
City of Industry, CA 91746
Main Line: 855.654.0110
Fax Line: 626.333.2955

8/7/2020

Specifications subject to change without notice.

Page 1 of 9



S700

SEAMLESS
LED Rigid Linear

Type	
Project	
Catalog No.	

ORDERING INFORMATION

MODEL	LENGTH*	CCT / CRI
S700		
	01 – 1-1/2"	2790 – 2700K (+/-150K) / 90CRI
	04 – 4"	3090 – 3000K (+/-150K) / 90CRI
	08 – 8"	3590 – 3500K (+/-200K) / 90CRI
	12 – 12"	4090 – 4000K (+/-200K) / 90CRI
	24 – 24"	**5090 – 5000K (+/-300K) / 90CRI
	36 – 36"	
	48 – 48"	
	**60 – 60"	

* Please refer to dimensions section below for actual dimensions.

** Contact Factory for options.

Example : S700-12-3090

NOTE: Full Spectrum option and higher lumen output options available. Contact factory for details.

DIMENSIONS

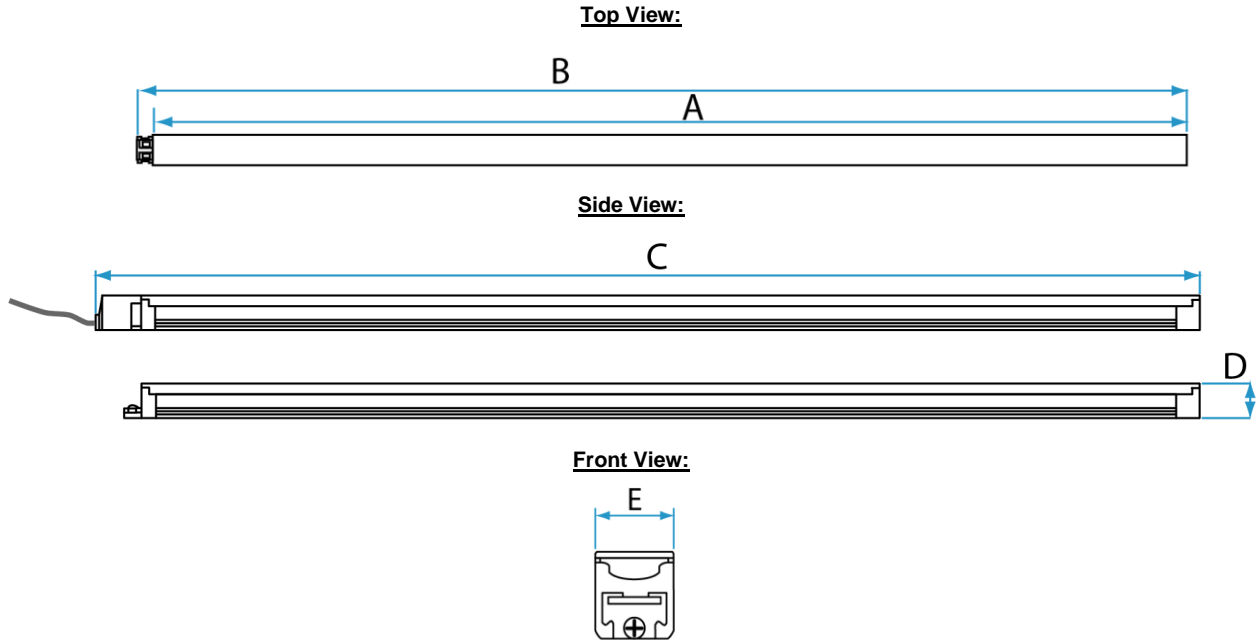

Part No.	Dimensions (A x E x D)	Lit Area (A)	Total Length (B)	Length with Power Cord Solid Piece (C)	Width (E)	Height (D)
S700-01	1-7/16"L x 7/16"W x 1/2"H (36L x 11W x 11.8H mm)	1-7/16" (36mm)	1-11/16" (42.1mm)	2-1/4" (56mm +/- 1mm)	7/16" (11mm)	1/2" (11.8mm)
S700-04	3-15/16"L x 7/16"W x 1/2"H (100L x 11W x 11.8H mm)	3-15/16" (100mm)	4-3/16" (106.1mm)	4-3/4" (120mm +/- 1mm)	7/16" (11mm)	1/2" (11.8mm)
S700-08	7-7/8"L x 7/16"W x 1/2"H (200L x 11W x 11.8H mm)	7-7/8" (200mm)	8-1/8" (206.1mm)	8-11/16" (220mm +/- 1mm)	7/16" (11mm)	1/2" (11.8mm)
S700-12	11-13/16"L x 7/16"W x 1/2"H (300L x 11W x 11.8H mm)	11-13/16" (300mm)	12-1/16" (306.1mm)	12-5/8" (320mm +/- 1.5mm)	7/16" (11mm)	1/2" (11.8mm)
S700-24	22-13/16"L x 7/16"W x 1/2"H (580L x 11W x 11.8H mm)	22-13/16" (580mm)	23-1/8" (586.1mm)	23-5/8" (600mm +/- 1.5mm)	7/16" (11mm)	1/2" (11.8mm)
S700-36	34-11/16"L x 7/16"W x 1/2"H (880L x 11W x 11.8H mm)	34-11/16" (880mm)	34-15/16" (886.1mm)	35-7/16" (900mm +/- 1.5mm)	7/16" (11mm)	1/2" (11.8mm)
S700-48	46-1/2"L x 7/16"W x 1/2"H (1180L x 11W x 11.8H mm)	46-1/2" (1180mm)	46-3/4" (1186.1mm)	47-1/4" (1200mm +/- 2mm)	7/16" (11mm)	1/2" (11.8mm)

All dimensions are nominal



www.jescolighting.com
 support@jescolighting.com
 Tech Support: 855.592.0029

15 Harbor Park Drive
 Port Washington, NY 11050
 Main Line: 800.527.7796
 Fax Line: 855.265.5768

219 South 6th Ave
 City of Industry, CA 91746
 Main Line: 855.654.0110
 Fax Line: 626.333.2955

8/7/2020

Specifications subject to change without notice.







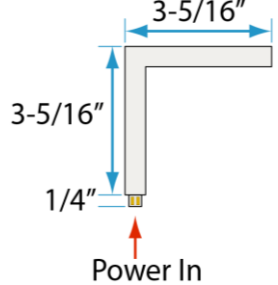

S700

**SEAMLESS
LED Rigid Linear**

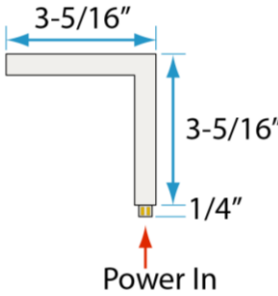
Type	
Project	
Catalog No.	

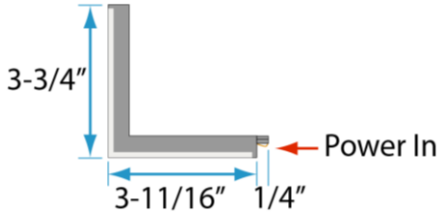
LIT CONNECTORS

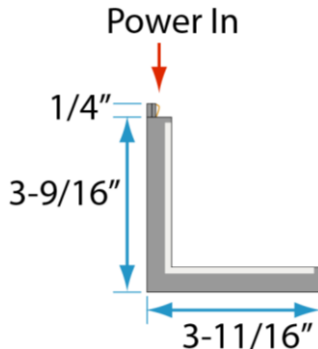
		Model-CCT	Description
		S700-LR-2790 S700-LR-3090 S700-LR-3590 S700-LR-4090	Lit Right L-connector. Clockwise direction of power. 24V DC 2.20W 150lm @4000K 90+ CRI Max. run = 16.4ft (2) S700-BR included (1) S700-LEC included (1) S700-DEC included
		S700-LL-2790 S700-LL-3090 S700-LL-3590 S700-LL-4090	Lit Left L-connector. Counter-clockwise direction of power. 24V DC 2.20W 150lm @4000K 90+ CRI Max. run = 16.4ft (2) S700-BR included (1) S700-LEC included (1) S700-DEC included
		S700-LO-2790 S700-LO-3090 S700-LO-3590 S700-LO-4090	Lit Outward Facing L-connector. Outward facing, counter-clockwise direction of power. 24V DC 2.22W 150lm @4000K 90+ CRI Max. run = 16.4ft (2) S700-BR included (1) S700-LEC included (1) S700-DEC included
		S700-LI-2790 S700-LI-3090 S700-LI-3590 S700-LI-4090	Lit Inward Facing L-connector. Inward facing, clockwise direction of power. 24V DC 2.22W 150lm @4000K 90+ CRI Max. run = 16.4ft (2) S700-BR included (1) S700-LEC included (1) S700-DEC included







S700

**SEAMLESS
LED Rigid Linear**

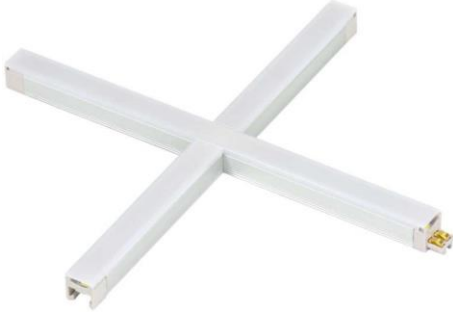
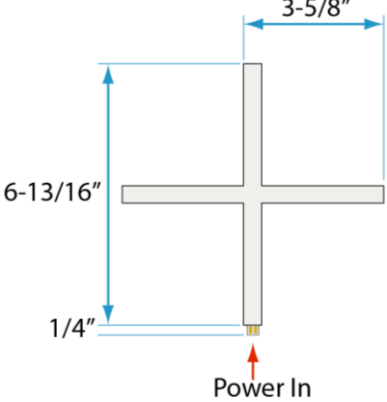
Type	
Project	
Catalog No.	

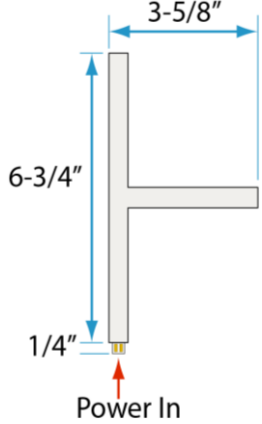
LIT CONNECTORS (Continued...)

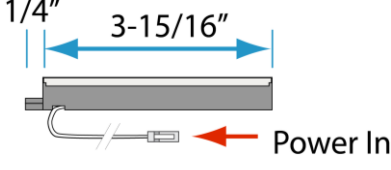
		Part Number	Description
		S700-X-2790 S700-X-3090 S700-X-3590 S700-X-4090	Lit X-connector. One input and three output connections. 24V DC 4.44W 310m @4000K 90+ CRI Max. run = 16.4ft (4) S700-BR included (1) S700-LEC included (3) S700-DEC included
		S700-TR-2790 S700-TR-3090 S700-TR-3590 S700-TR-4090	Lit T-connector. One input and two output connections. 24V DC 3.55W 260lm @4000K 90+ CRI Max. run = 16.4ft (3) S700-BR included (1) S700-LEC included (2) S700-DEC included
		S700-EXTBSF-2790 S700-EXTBSF-3090 S700-EXTBSF-3590 S700-EXTBSF-4090	Lit Extender with Bottom and Side Feed connector. An in-line connector that allows two separately powered runs to be linked seamlessly for an extended uninterrupted run. Click the end of one run into the dead end of the connector and power the rest of the run with cables that can exit the side or bottom of the connector. Also allows for closed circuit shapes such as squares and rectangles. Wire length: 60" Type G connector 24V DC 1.25W 88lm @4000K 90+ CRI Max. run = 16.4ft (1) S700-BR included (1) S700-LEC included (1) S700-DEC included

All dimensions are nominal



www.jescolighting.com
 support@jescolighting.com
 Tech Support: 855.592.0029

15 Harbor Park Drive
 Port Washington, NY 11050
 Main Line: 800.527.7796
 Fax Line: 855.265.5768

219 South 6th Ave
 City of Industry, CA 91746
 Main Line: 855.654.0110
 Fax Line: 626.333.2955

8/7/2020

Specifications subject to change without notice.







S700





**SEAMLESS
LED Rigid Linear**

Type	
Project	
Catalog No.	



ACCESSORIES

	Part Number Description
	S700-PC12 12" Power cord with Type G connector for S700. 20AWG wire
	S700-PC60 60" Power cord with Type G connector for S700. 20AWG wire
	S700-PC60-HW 60" Power cord Hardwire connection for S700. 20AWG wire
	S700-CC06 6" Connecting cable
	S700-CC12 12" Connecting cable
	S700-CC24 24" Connecting cable 20AWG wire

All dimensions are nominal

	Part Number Description
	S700-DIM In-line touch on/off and dimmer with memory. 24VDC / 72W Max. 2-15/16"L x 7/16"W x 1/2"H
	DB-CV-DC/PG-12 12-Port distribution-block for Type G connectors. 12-24VDC Max. Wattage (total): 72W Max. Wattage (per channel): 72W 6" wire with Barrel connector 3-1/8"L x 1-5/16"W x 11/16"H
	DB-CV-DC/PG-1 Adapter to convert Type G connector to Barrel connector 20AWG 6" wire
	S700-LEC Live end-cap (1) Included with every fixture.
	S700-DEC Dead end-cap (1) Included with every fixture.

MOUNTING ACCESSORIES

	Part Number	Description
	S700-BR	Plastic mounting bracket with screws (1) included with 4" fixture. (2) included with 8", 12" and 24" fixture. (3) included with 36" and 48" fixture.
	S700-BR45	45 degree plastic mounting bracket with screws (1) recommended for 4" fixture. (2) recommended for 8", 12" and 24" fixture. (3) recommended for 36" and 48" fixture.
	ACC-MT-MET-01	Metal tab are provided with double-sided adhesive on one side. No drilling is required. The tabs must be aligned with the magnets at the back of the fixture.

All dimensions are nominal



www.jescolighting.com
support@jescolighting.com
Tech Support: 855.592.0029

15 Harbor Park Drive
Port Washington, NY 11050
Main Line: 800.527.7796
Fax Line: 855.265.5768

219 South 6th Ave
City of Industry, CA 91746
Main Line: 855.654.0110
Fax Line: 626.333.2955

8/7/2020

Specifications subject to change without notice.



S700

**SEAMLESS
LED Rigid Linear**

Type	
Project	
Catalog No.	

PHOTOMETRIC DATA

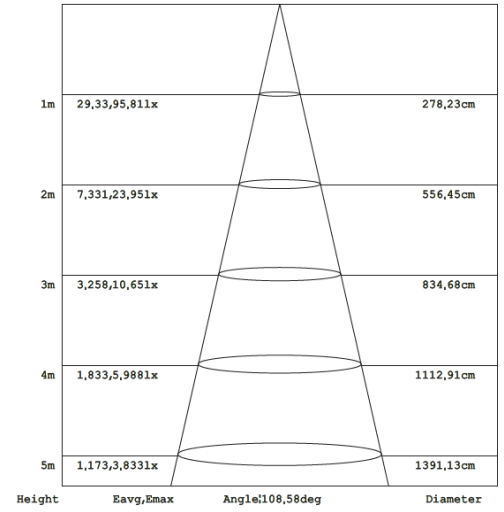
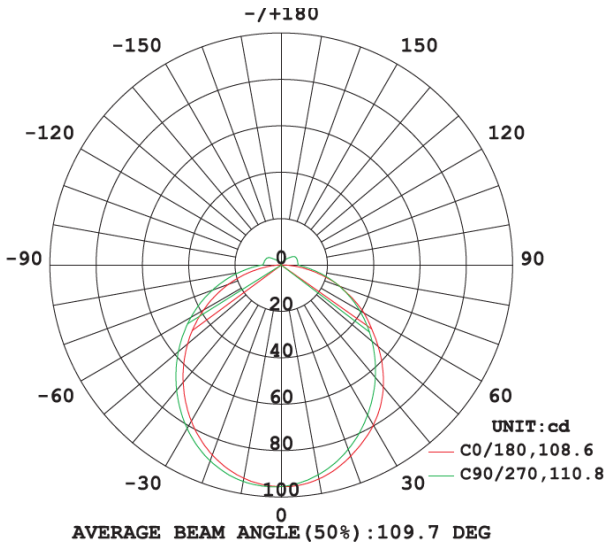

*for S700-12-4090

POWER SUPPLIES

**24V Hard-Wire Power Supplies
UL Recognized. Class 2**

Model Number	Wattage
DL-PS-20/24-HWA	20
DL-PS-60/24-HWA	60
DL-PS-96/24-HWA	96

**24V Hard-Wire Power Supplies in Junction Box
UL Listed. Class 2**

Model Number	Wattage
DL-PS-20/24-JBA	20
DL-PS-60/24-JBA	60
DL-PS-96/24-JBA	96

**24V Hard-Wire Triac Dimmable Power Supplies in Junction Box
UL Listed. Class 2**

Model Number	Wattage
DL-PS-40/24-JB-DIM*	40
DL-PS-60/24-JB-DIM*	60
DL-PS-100/24-JB-DIM*	96

*Min. 18W load required for proper dimming

**24V Hard-Wire Triac Dimmable Power Supplies
UL Recognized. Class 2**

Model Number	Wattage
DL-PS-40/24-HW-DIM*	40
DL-PS-60/24-HW-DIM*	60
DL-PS-100/24-HW-DIM*	96

*Min. 18W load required for proper dimming

**24V Hard-Wire 0-10V Dimmable Power Supplies in Junction Box
UL Listed (with Junction Box)**

Model Number	Wattage
DL-PS-30/24-JB-OD-DIM	30W
DL-PS-60/24-JB-OD-DIM	60W
DL-PS-96/24-JB-OD-DIM	96W

**24V Plug and Play Power Supplies
UL Listed**

Model Number	Wattage
DL-PS-WP24/24	24
DL-PS-24/24	24
DL-PS-48/24	48
DL-PS-60/24	60
DL-PS-60/24-CL2*	60
DL-PS-90/24-CL2*	90
DL-PS-100/24-CL2*	96

* Class 2

NOTE: UL Recognized drivers must be installed in a UL Listed junction box



www.jescolighting.com
 support@jescolighting.com
 Tech Support: 855.592.0029

15 Harbor Park Drive
 Port Washington, NY 11050
 Main Line: 800.527.7796
 Fax Line: 855.265.5768

219 South 6th Ave
 City of Industry, CA 91746
 Main Line: 855.654.0110
 Fax Line: 626.333.2955

8/7/2020

Specifications subject to change without notice.



Type	
Project	
Catalog No.	

WIRING DIAGRAMS

PLUG AND PLAY – With distribution block

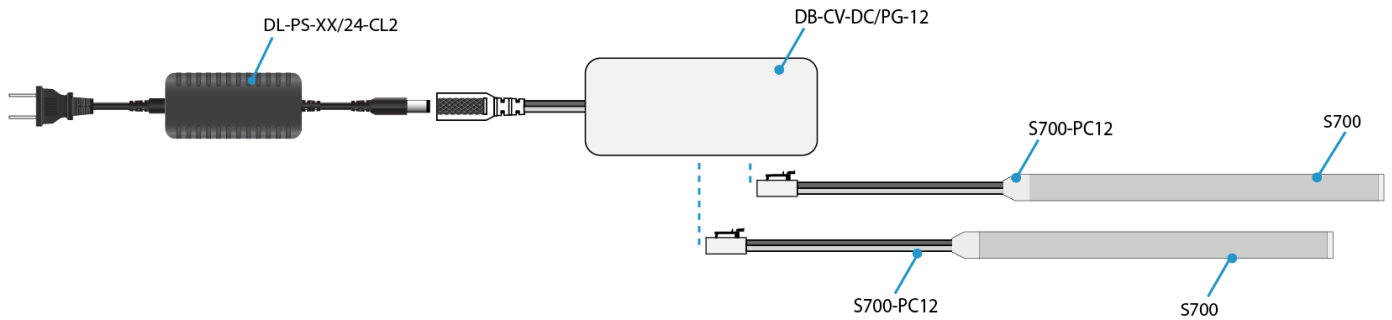

PLUG AND PLAY – With adapter

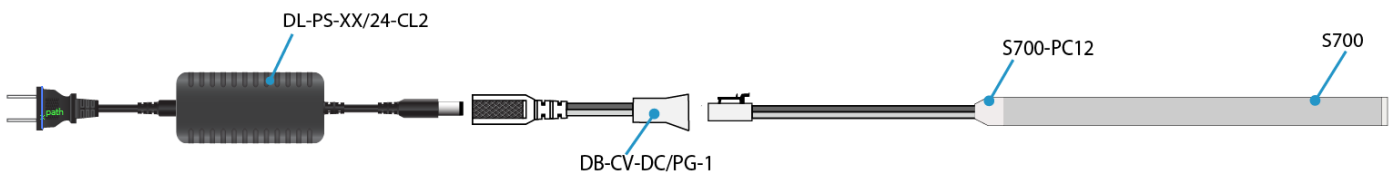

HARDWIRE

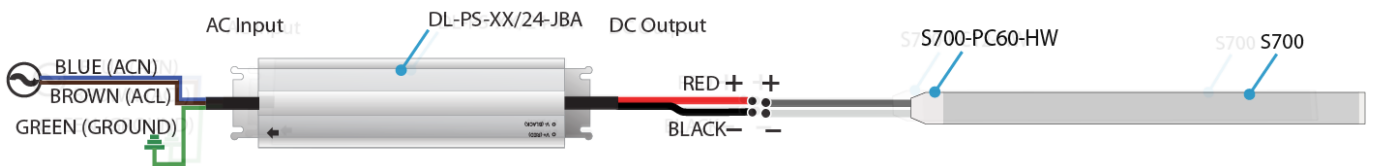

DIMMING OPTION – Using S700-DIM inline dimmer – with plug and play driver and distribution block

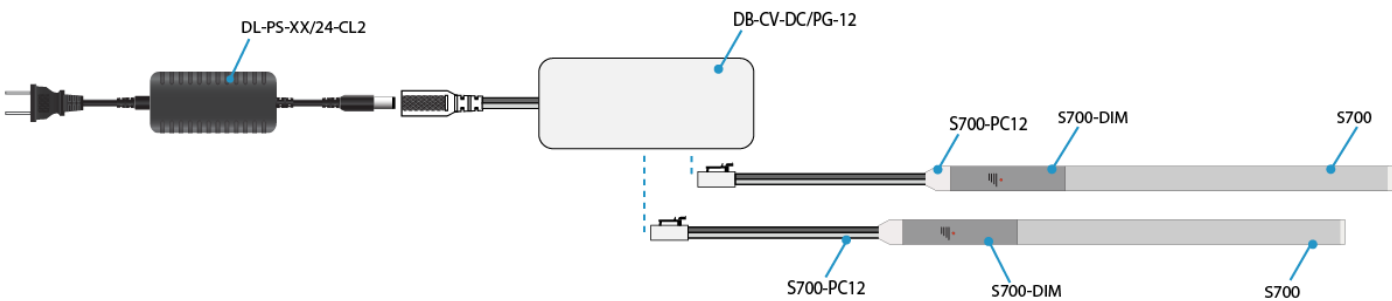

DIMMING OPTION – Using S700-DIM inline dimmer – with plug and play driver and adapter

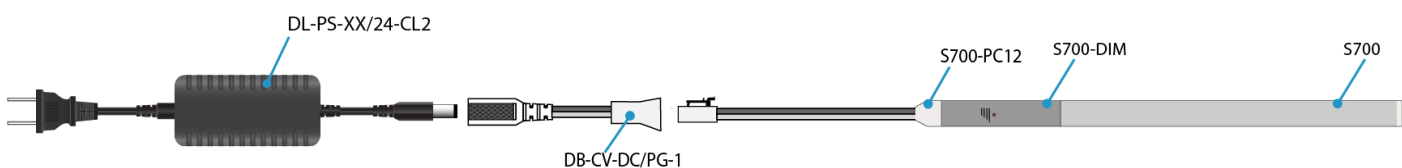



S700

**SEAMLESS
LED Rigid Linear**

Type	
Project	
Catalog No.	

DIMMING OPTION – Using S700-DIM inline dimmer – with hardwire driver

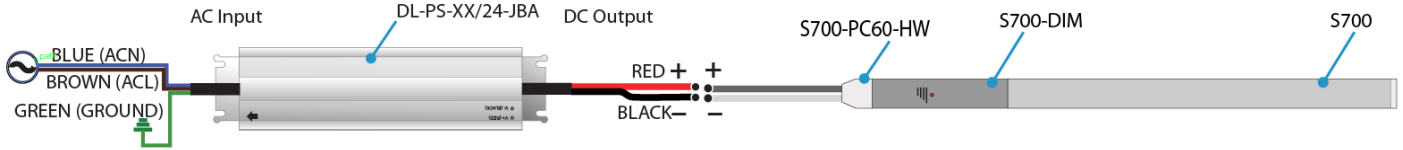

DIMMING OPTION – TRI-AC (Using our DL-PS-XX/24-JB-DIM or DL-PS-XX/24-HW-DIM drivers). Minimum 18W load is required

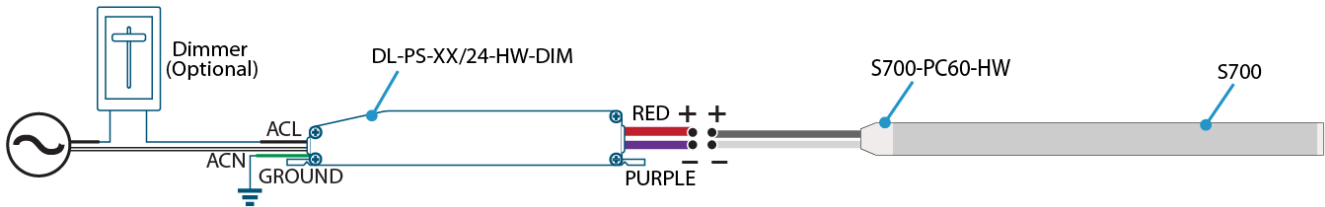

NOTE: UL Recognized drivers must be installed in UL Listed junction box

DIMMING OPTION – 0-10V Plug and Play (Using our LC-DIM-5A Dimming Module), with distribution block

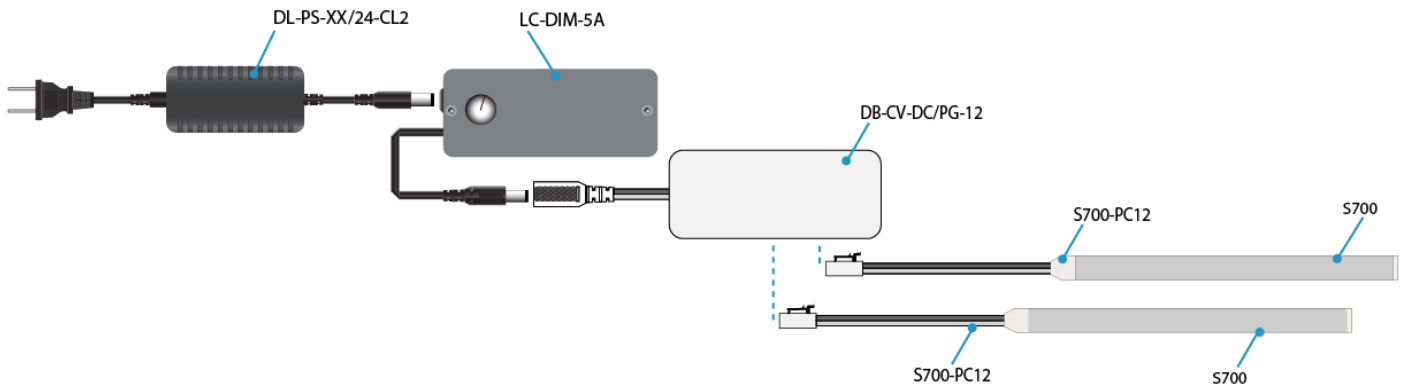

DIMMING OPTION – 0-10V Plug and Play (Using our LC-DIM-5A Dimming Module), with adapter

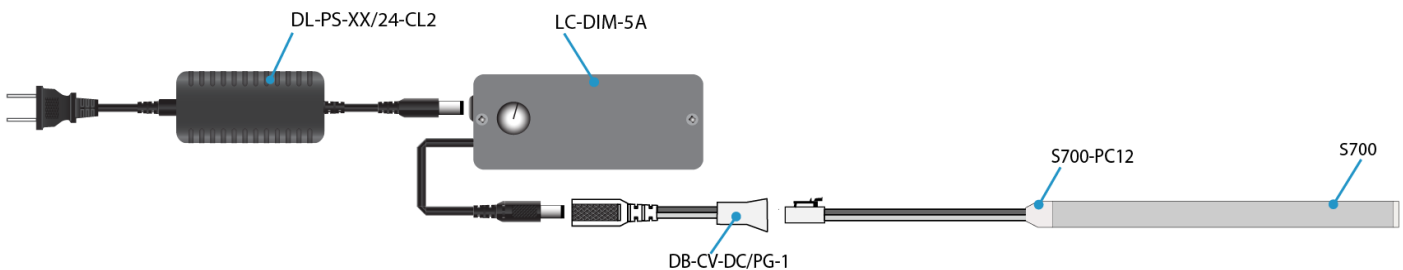



S700

SEAMLESS
LED Rigid Linear

Type	
Project	
Catalog No.	

DIMMING OPTION – 0-10V Hardwire (Using our LC-DIM-5A-HW Dimming Module)

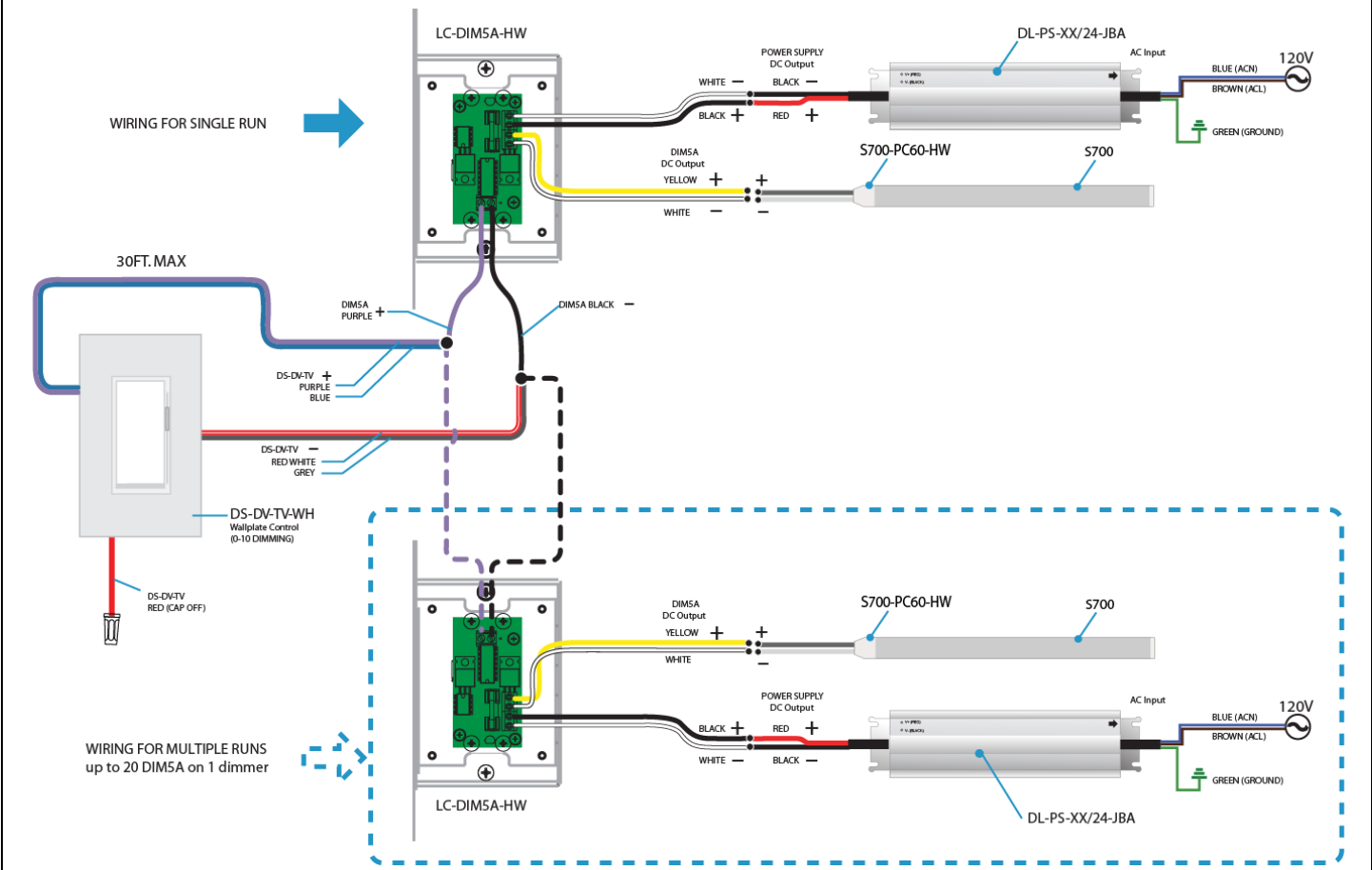

Using the S700-EXTBSF to seamlessly extend past max. run

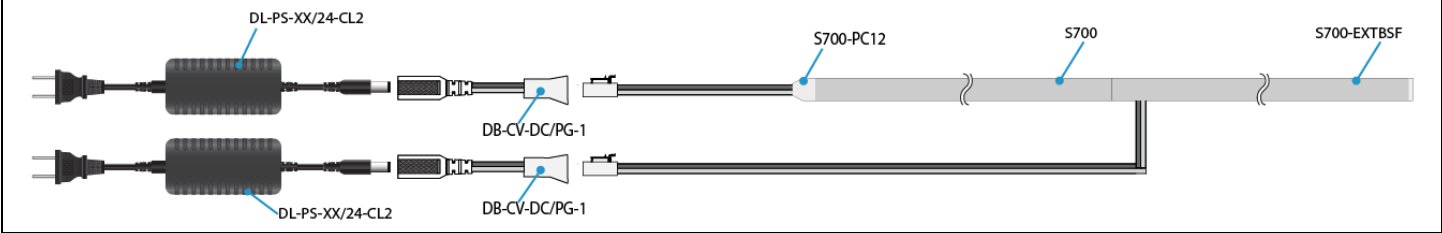

DIMMING OPTION – 0-10V (Using our DL-PS-XX/24-JB-OD-DIM drivers).

