

# SEAMLESS

## S700 LINKABLE SERIES





**SEAMLESS** is a rigid LED fixture that allows designers to imagine continuous lighting designs in a three dimensional plane.

Linear fixtures, in multiple length options, simply connect either in a straight line, in a closed loop, or in multiple directions using lift L, T or X connectors or inside and outside facing lift connectors...seamlessly.



# SEAMLESS • S700 LINKABLE SERIES



Opal Lens  
assures even light,  
no hot spots



Snap-in Power  
Input Connector

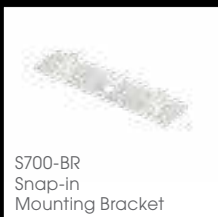

S700-BR  
Snap-in  
Mounting Bracket



Integral  
Magnets



Inline Lit Extender

Each fixture is provided with integral magnets for easy mounting as well as snap-in mounting brackets for non-metallic surfaces.

The maximum run of the S700 is 16.4 feet but extra long runs may be achieved with use of the inline Lit Extender, S700-EXTBSF, with bottom and side power feeds which allows multiple runs to be seamlessly interconnected and fed with separate power supplies. Also now achievable are closed circuit shapes such as squares and rectangles.

# SEAMLESS MODULARITY

**SEAMLESS** is JESCO Lighting's premier LED linear fixture.

Each S700 fixture is linkable end-to-end with no dark spots, even at connections between fixtures or connectors. Inter-connectable lit L-type corners provide for seamless turns - clockwise, counter-clockwise, inside-facing and outside-facing - allowing the fixture to change directions either on a horizontal or a vertical plane. Lit X- and T-type connectors are also available for a wide range of design possibilities. A uniform light output allows for intricate and complex layouts free from any break in the flow of light. Mounted with integral magnets at the back of every fixture or with the snap-in mounting brackets for non-metallic surfaces (included).



**S700-LI**  
Lit Inward Facing  
L-connector



**S700-LR**  
Lit Right  
L-connector  
Clockwise  
direction of  
power



**S700-LL**  
Lit Left  
L-connector  
Counter-  
clockwise  
direction of  
power

## FORM + FUNCTION

- Seamless connections between fixtures
- No hot spots, even at connections between fixtures or connectors
- Long runs may be interconnected seamlessly with inline Lit Extender with bottom and side feed
- Lit inside and outside connectors in L, X and T patterns allow for lighting designs in three dimensional planes
- IC chips assure near zero light output lost from the beginning to the end of runs
- Ultra-bright 3-step MacAdam LEDs offer tight color output with a CRI >90
- Integral magnets for easy mounting
- Optional snap-in 0° or 45° mounting clips

## S700

### SEAMLESS - LINKABLE SERIES

LED	24V DC	70 Lm/W	90+ CRI	63 LED/Ft
16.4' MAX <sup>1</sup>	DIM	120°	DAMP LISTED	UL LISTED

**Material:** Aluminum body with Opal lens

**Dimensions:** 7/16" W x 1/2" H

**Includes:** (1) Live End Cap, (1) Dead End Cap, Mounting Brackets

**Environment:** UL Listed for damp locations

<sup>1</sup> Runs may be seamlessly extended with use of S700-EXTBSF  
Lumen data based on 4000K



**S700-TR**  
Lit T-connector



**S700-LO**  
Lit Outward Facing  
L-connector

## APPLICATIONS

- Under-shelf and under-cabinet lighting
- Retail lighting
- Showcase lighting
- Display lighting
- Accent and edge lighting
- Cove and soffit lighting
- Interesting window display

Model	Length	Watts	Lumens
<b>S700-01</b>	1 1/2"	0.4W	27.8 Lm
<b>S700-04</b>	3 15/16"	1.3W	88 Lm
<b>S700-08</b>	7 7/8"	2.5W	176 Lm
<b>S700-12</b>	11 13/16"	3.7W	259 Lm
<b>S700-24</b>	22 13/16"	8.0W	560 Lm
<b>S700-36</b>	34 11/16"	12.0W	840 Lm
<b>S700-48</b>	46 1/2"	16.0W	1120 Lm

Lumen data based on 4000K



**S700-BR**  
Snap-In  
Mounting Bracket  
(included)



Opal Lens  
assures even light,  
no hot spots  
(included)



Integrated magnets  
allow for easy  
mounting. Snap-in  
mounting brackets  
also provided.

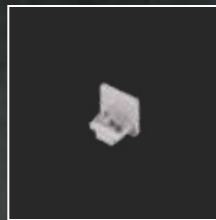

**S700-DEC**  
Dead End Cap  
to cleanly finish runs  
(included)

## TO ORDER

MODEL	LENGTH <sup>2</sup>	CCT <sup>3</sup>
<b>S700</b>	-	-
	<b>01</b> - 1 1/2"	<b>2790</b> - 2700K 90CRI
	<b>04</b> - 3 15/16"	<b>3090</b> - 3000K 90CRI
	<b>08</b> - 7 7/8"	<b>3590</b> - 3500K 90CRI
	<b>12</b> - 11 13/16"	<b>4090</b> - 4000K 90CRI
	<b>24</b> - 22 13/16"	<b>5090</b> - 5000K 90CRI*
	<b>36</b> - 34 11/16"	
	<b>48</b> - 46 1/2"	
	<b>60</b> - 60"*	

\* Contact factory

<sup>2</sup> Lit lens length. For length of complete fixture add 1/4"

<sup>3</sup> For other CCTs and CRIs, contact factory

# SEAMLESS • S700 LIT CONNECTORS

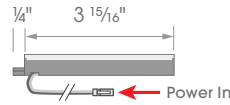

## S700-EXTBSF

### Lit Extender with Bottom and Side Feed connector

An in-line connector that allows two separately powered runs to be linked seamlessly for an extended uninterrupted run. Click the end of one run into the dead end of the connector and power the rest of the run with cables that can exit the side or bottom of the connector. Also allows for closed circuit shapes such as squares and rectangles.

Wattage: 1.25W  
Lumens: 88Lm @4000K  
Wire Length: 60" with Type G Connector  
Dimensions: 4 3/16" L x 1/2" H x 1/2" W

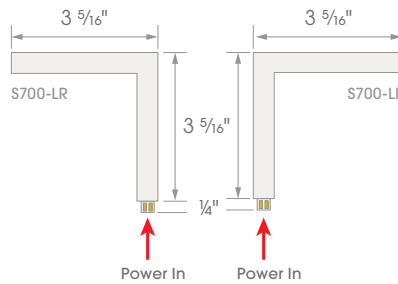

## S700-LR

### Lit Right L-connector

Clockwise direction of power

## S700-LL

### Lit Left L-connector

Counter-clockwise direction of power

Wattage: 2.20W  
Lumens: 150Lm @4000K  
Fixture Profile: 1/2" H x 1/2" W

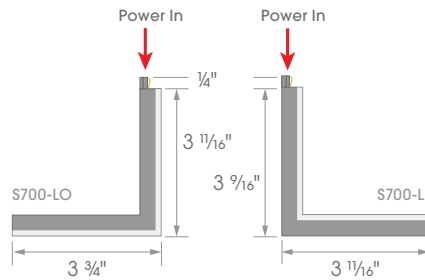

## S700-LI

### Lit Inward Facing L-connector

Inward facing, clockwise direction of power

## S700-LO

### Lit Outward Facing L-connector

Outward facing, counter-clockwise direction of power

Wattage: 2.22W  
Lumens: 150Lm @4000K  
Fixture Profile: 1/2" H x 1/2" W

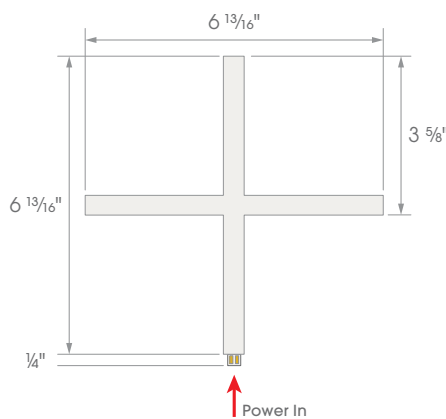

## S700-X

### Lit X-connector

One input and three output connections

Wattage: 4.44W  
Lumens: 310Lm @4000K  
Fixture Profile: 1/2" H x 1/2" W

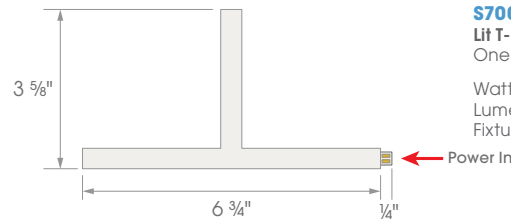

## S700-TR

### Lit T-connector

One input and two output connections

Wattage: 3.55W  
Lumens: 260Lm @4000K  
Fixture Profile: 1/2" H x 1/2" W

Input: 24V DC • CRI: 90+ • Max. Run: 16.4' • Available in 2700K, 3000K, 3500K & 4000K  
To Order Connectors Specify: **Model Number - CCT**

## S700 ACCESSORIES



**S700-PC12**  
12" Power Cord with Type G Connector  
**S700-PC60**  
60" Power Cord with Type G Connector



**S700-PC60-HW**  
60" Power Cord Hardwire Connection



**S700-CC06, S700-CC12**  
**S700-CC24**  
Connecting Cables  
6", 12" and 24"



**S700-DIM**  
In-line Touch ON/OFF and Dimmer  
with Memory  
2 15/16" L x 7/16" W x 1/2" H



**DB-CV-DC/PG-12**  
12-Port Type G Distribution Block  
with DC Jack and 6" lead



**DB-CV-DC/PG-1**  
Type G to DC Jack Adapter



**S700-BR45**  
45° Plastic Mounting Brackets  
Screws included.

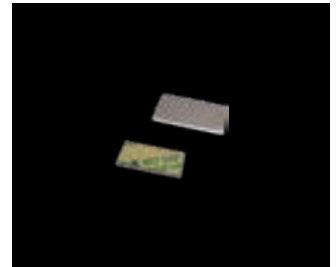

**ACC-MT-MET-01**  
Metal Tab with 3M adhesive on one side  
for mounting on nonmetallic surfaces without  
drilling. Must be applied to S700 fixture at the  
back where the magnets are located.

## POWER SUPPLIES

### 24V PLUG & PLAY DRIVERS

<b>DL-PS-WP24/24</b>	24W - 24V	Wall-Plug LED Driver
<b>DL-PS-24/24</b>	24W - 24V	Desktop LED Driver
<b>DL-PS-48/24</b>	48W - 24V	
<b>DL-PS-60/24</b>	60W - 24V	
<b>DL-PS-60/24-CL2</b>	60W - 24V	Desktop LED Driver, Class 2
<b>DL-PS-90/24-CL2</b>	90W - 24V	
<b>DL-PS-100/24-CL2</b>	96W - 24V	

### 24V HARDWIRE DRIVERS

<b>DL-PS-20/24-JBA</b>	20W - 24V	Hardwire LED Driver in Junction Box
<b>DL-PS-60/24-JBA</b>	60W - 24V	
<b>DL-PS-96/24-JBA</b>	96W - 24V	
<b>DL-PS-40/24-JB-DIM</b>	40W - 24V	Hardwire LED Driver in Junction Box - Triac Dimmable
<b>DL-PS-60/24-JB-DIM</b>	60W - 24V	
<b>DL-PS-100/24-JB-DIM</b>	96W - 24V	

For 0-10V dimming contact factory



### RADIANZ REMOTE POWER SYSTEM

<b>BATT-LI-24V-100WH</b>	24V - 100Wh	100 Watt/hours Battery Pack
<b>BATT-LI-24V-150WH</b>	24V - 150Wh	150 Watt/hours Battery Pack
<b>BATT-LI-24V-266WH</b>	24V - 266Wh	266 Watt/hours Battery Pack



### ST SERIES SMART TRACK

Compatible with ST series Smart Track.  
See specifications.

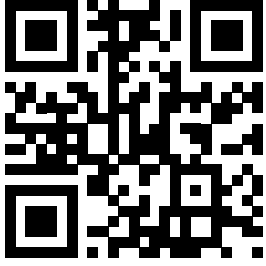

For more details and product specifications please visit [JESCOLIGHTING.COM](http://JESCOLIGHTING.COM)



**NEW YORK  
CORPORATE OFFICE**

15 Harbor Park Drive  
Port Washington NY 11050  
TEL 800 527 7796  
FAX 855 265 5768

**LOS ANGELES**

219 South 6th Avenue  
City Of Industry CA 91746  
TEL 626 333 3661  
TEL 855 654 0110  
FAX 626 333 2955

[JESCOLIGHTING.COM](http://JESCOLIGHTING.COM)  
[info@jescolighting.com](mailto:info@jescolighting.com)

© 2020 JESCO LIGHTING

LCAT-S700-2

